

Advanced  
Poly-Packaging, Inc.

P r o d u c t   C a t a l o g   V

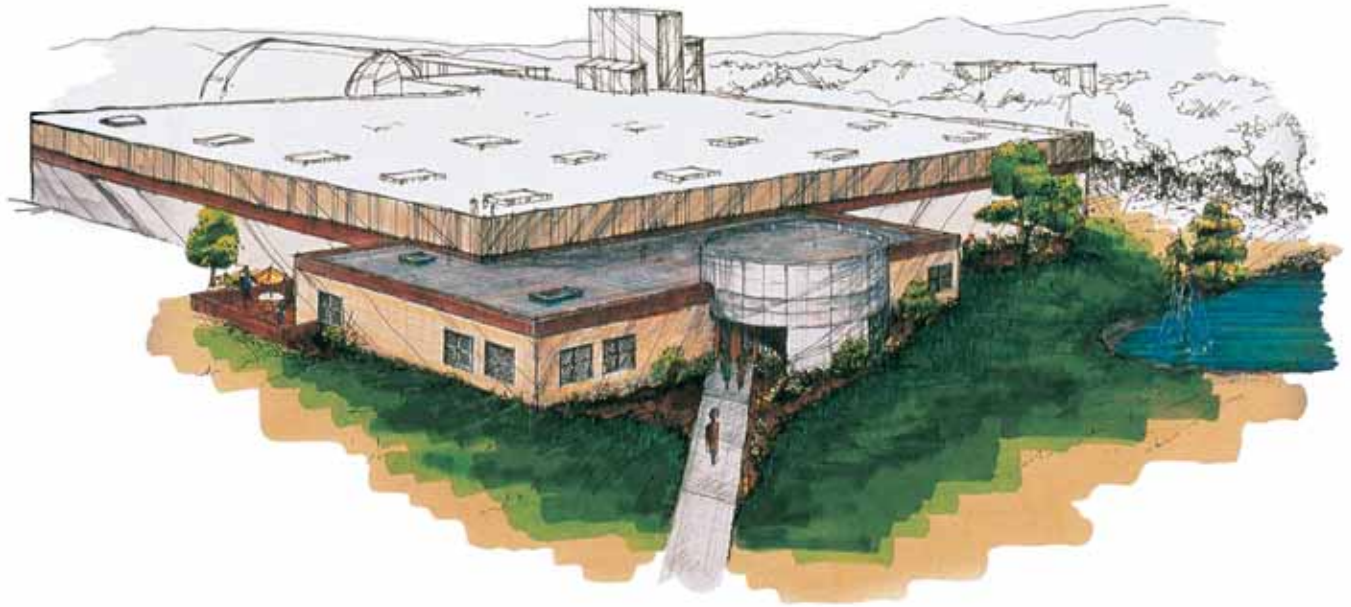

# Advanced Poly-Packaging, Inc.



## Why Choose Advanced Poly-Packaging?

Because we are Solutions-Driven! Solutions don't come from individuals. They're formulated by teams. That's what you get at Advanced Poly-Packaging – teams of packaging professionals who can discuss your application and send bag samples, quotes, product evaluations or other tools you may need. We are proud to introduce you to our products and show you how they will increase your production – and your bottom line!

Advanced Poly-Packaging is not only learning about innovation – we're creating it through continued research & development investments. We're also investing in new technology that allow our customers to conduct more business online.

The company was founded in 1979 by Tony Baker and remains family-owned. Our headquarters are located in Akron, Ohio and all of our products are made in the USA!

Do you want to see our products in action? Visit our website at [www.advancedpoly.com](http://www.advancedpoly.com) for videos as well as links to our social media channels.

Contact us – US:  
800.754.4403  
[sales@advancedpoly.com](mailto:sales@advancedpoly.com)  
Europe:  
+44 (0) 1452 85445  
[salesuk@advancedpoly.com](mailto:salesuk@advancedpoly.com)

[www.AdvancedPoly.com](http://www.AdvancedPoly.com)



Disclaimer: The information provided in the following pages is for promotional purposes. Specifications in this literature are subject to change without notice. Products listed may not be suitable to package your products; therefore, we can provide samples of our products for your testing and evaluation to determine if they meet your requirements. We recommend samples of your products to determine suitability, proposed equipment and options, production speeds, final package size/configuration and estimated production speeds. Performance guarantees are available for machines and bags but vary from product to product. Please request a guarantee that is tied to a specific quote from Advanced Poly. Performance guarantees are subject to change without notice..

# Table of Contents

Page #

|                                |   |       |
|--------------------------------|---|-------|
| <b>POLY BAGS</b>               | Custom Bags .....   | 4     |
|                                | Stock Bags .....  | 5     |
|                                | Specialty Films .....                                       | 6-7   |
| <b>TABLETOP BAGGERS</b>        | T-200 Tabletop Bagger/Sealer .....                          | 10    |
|                                | T-275 Automatic Tabletop Bagger .....                       | 11    |
|                                | T-300 Automatic Tabletop Bagger .....                       | 12    |
|                                | T-375 Automatic Tabletop Bagger/Printer .....               | 13    |
| <b>PRODUCTION BAGGERS</b>      | T-1000 Advanced Poly-Bagger™ .....                          | 14    |
|                                | T-1000 Configuration Samples .....                          | 15    |
|                                | T-1000 Options & Accessories .....                          | 16-19 |
|                                | T-1000H (Horizontal Models) .....                           | 20-21 |
|                                | T-1000 Medical .....  | 22    |
| <b>T-1000 SYSTEMS</b>          | US-5000 “Flip” Net-Weigh/Counting Scale .....               | 24    |
|                                | US-5500 Net-Weigh/Counting Scale .....                      | 25    |
|                                | UF-5000 Cleated Compartment Infeed Conveyor .....           | 26    |
|                                | UC-2400 Vibratory Parts Counter .....                       | 27    |
|                                | US-9000 Vibratory Bowl Net-Weigh/Counting Scale .....       | 28    |
|                                | UCS-2400 3-in-1 Parts Counter & Scales .....                | 29    |
|                                | US-7000 Net-Weigh, Single or Dual Head Scale .....          | 30    |
|                                | US-8000 “Combi” Net-Weigh Scale .....                       | 31    |
|                                | US-4000 Rotary Check-Weigh Scale .....                      | 32    |
|                                | US-6000 Conveyor Check-Weigh Scale .....                    | 33    |
|                                | UF-2000 Incline Takeaway Conveyor .....                     | 34    |
|                                | UF-3020 Vibratory Hopper/Conveyor - Light Duty .....        | 34    |
|                                | UF-3040 Vibratory Hopper/Conveyor - Medium Duty .....       | 35    |
|                                | UF-3060 Metal Bucket Hopper/Conveyor - Heavy Duty .....     | 35    |
| <b>PRINTERS</b>                | Ti-1000Z & Options/Accessories .....                        | 16    |
|                                | Roll-A-Print Stations: Ti-1000Z RAP; RAP1400; RAP2800 ..... | 36-37 |
| <b>SPECIAL PURPOSE SYSTEMS</b> | General Description .....                                   | 39    |
|                                | TSP-1000 Seal Pouch System .....                            | 40-41 |
|                                | ST-1000 Automatic Towel Inspection & Bagging System .....   | 42    |
|                                | US-6000 Carton Check-Weigh System .....                     | 33    |
|                                | BF-4000 Box Filling System .....                            | 43    |
| <b>OTHER INFORMATION/TOOLS</b> | Bagger/Printer Specification Chart .....                    | 38    |
|                                | Engineering .....   | 3     |
|                                | Refurbished Equipment .....                                 | 44    |
|                                | Product Evaluation .....                                    | 45    |

# The Advanced Poly Advantage

Anyone can sell a machine, but Advanced Poly commits to meeting your expectations. While attempting to fully understand your expectations, our transparent approach sets us apart:

**Product Evaluations** – Free evaluations provide not only complete equipment specifications but also provide the operational method, anticipated labor, operator duties and potential issues. How often do manufactures tell you what issues you may have?

**Performance Guarantee** – Advanced Poly guarantees every system we produce, even customized systems. We guarantee that each system meets or exceeds the designed level of performance and if we can't achieve that level, we authorize a return.

**Off-the-Shelf Parts** – When locally-stocked parts can be used, you bet our engineers will incorporate those into our design which provides the lowest downtime possible.

**Standardized Parts** – Because our systems are modular, Advanced Poly uses standardized parts, whenever possible, across our entire machinery product line. Every system has the same controls package, pneumatics package and drive package. That means spare parts are uniform and a reduction in maintenance training.

**Engineering Services** – Need to integrate our systems with existing production equipment? No problem: We have integrated our bagging systems, counting systems or scale systems into countless production machines. 3D drawings and illustrations are supplied so you know exactly what you will receive and can approve the concepts with confidence.

**Troubleshooting and Logging** – Need to know why you lost production last night? Our standard event log function will tell you why. Uptime/downtime reporting, causes for stoppages and time to correct are all logged so operators cannot make excuses.

**Long Warranty** – When tied to a materials program, don't expect to purchase a part (other than normal wear items) for at least TWO YEARS with a possible extension for many more years. Our goal is limit your equipment expense by partnering with Advanced Poly.

These concepts are foreign to many machine manufacturers and that is what sets Advanced Poly apart. We take the worry out of determining what equipment is required, whether the machine will work, and how long it will last.



## What else should you expect from our machines?

- **Speed** – Whether indexing, transporting, weighing or sealing, the rate of production will save you money.
- **Versatility** – Our machines will accept nearly any pre-opened bags on rolls and easily integrate with other machinery components.
- **Reliability** – High-quality design, parts selection and quality of craftsmanship combine to make our machines ready for a rigorous manufacturing environment. These machines are built for continuous use with minimal maintenance.
- **Simplicity** – We leave the hard part to our engineers! You get the ease of on-screen instruction and the ability to save dozens of settings for future runs.

# Engineering, Customization & Programming

Our ability to provide sensible, cost-effective bagging solutions starts with engineering. Our experienced, innovative staff understands what it means to wrap our capabilities around your needs – not the other way around. The hundreds of ways a standard machine can be modified depends on your product. You may need a bag opening device, a custom funnel, or a load shelf. You may need something more complicated.

Advanced Poly-Packaging continues to invest in technology and the people who know how to use it, including the latest SolidWorks software, making the design phase of your project faster and more accurate. In fact, we'll provide you the ability to approve the design through a free viewer program that enables you to see inside the machine, view any imaginable angle, zoom in to specific components, etc. eDrawing Viewer allows you to essentially see how the machine works before we build it, leaving your mind at ease that you're getting a well-engineered piece of equipment with no guessing!

Various drawings and illustrations are available throughout the process, including screen shots, when applicable, for customized operational setups.

**From Concept...**

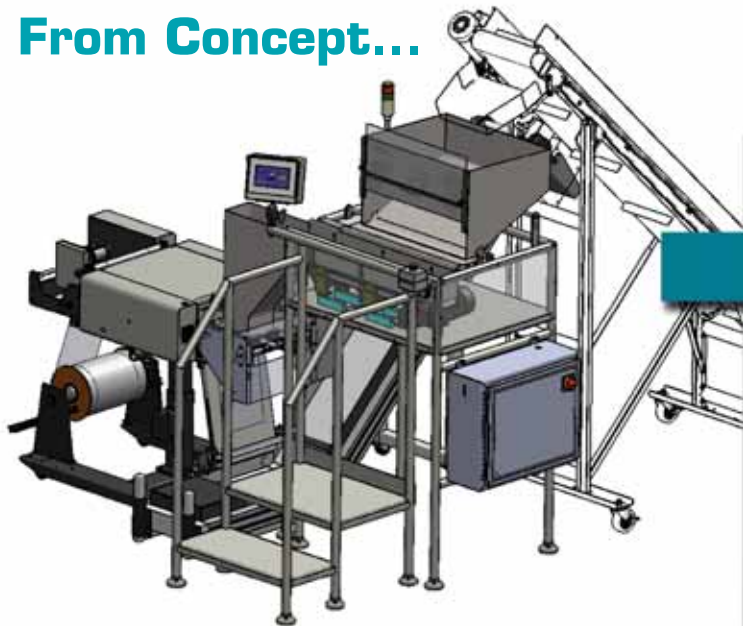

**To Design...**

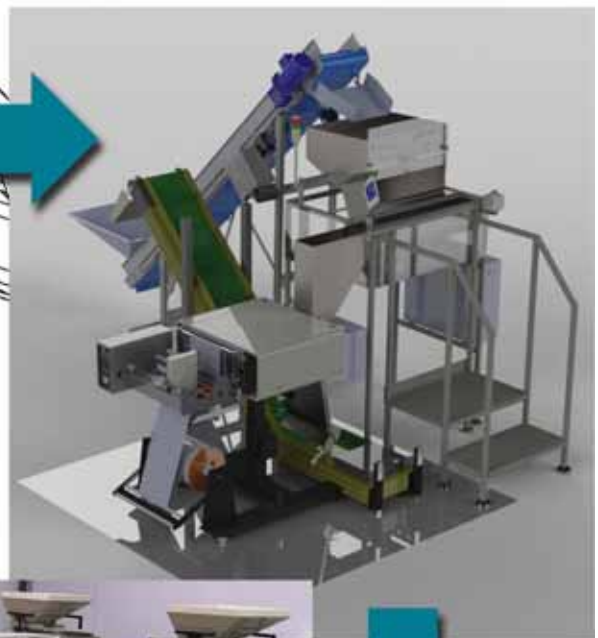

**To Reality!**



# Custom Bags – Our Specialty!



Advanced Poly “Zipper Pouch” bags

You may prefer a specialized film for better presentation or preservation of your product. Advanced Poly-Packaging uses the highest quality raw materials to create a superior bag that reflects the clarity, strength, print adhesion or barrier qualities that best suit your application! Review the many options on pages 6-7.

Advanced Poly Packaging manufactures all types of custom poly bag orders. We offer printed and non-printed bags for all types:

- On rolls
- In boxes
- Sideweld
- Pouches
- Zipper Pouch

## Make an impression with your bags!

Add colors and special features to your custom bags. Our complete printing capabilities allow up to six (6) colors on two (2) sides for line, screen and process printing. Advanced Poly-Packaging can also add a variety of special features to your custom bags including:

- Special holes (OSHA, butterfly, triangular, round)
- High integrity seals
- Perforations (vertical, horizontal, tear-notch)
- Headers
- Specialty films

Allow us to design your bags. Advanced Poly-Packaging’s in-house graphic designers can create your perfect bag using just the right artwork, typesetting and color separations.

We maintain high quality standards so our bags and pouches meet yours ... and we guarantee it! Ask for a copy of our Performance Guarantee.



# Stocking Programs and Stock Bag Sizes

Lower inventory costs and improve cash flow by letting us stock your bags!

Take advantage of our Blanket Order Program. You can get large quantity price breaks, but take delivery over a period of 6 months! Never run out of bags – we manufacture them and store them in our warehouse. Shipping and billing takes place on scheduled release dates (or sooner).

Whether large quantities or just a few rolls at a time, Advanced Poly-Packaging, Inc. offers dozens of stock bag sizes, ready for shipment within hours of receiving your emergency order!

Don't let nicknames fool you! We sell bags according to their mil thickness.

We also have an extensive list of "Overstock" bags. Visit our website for a complete listing.



## Stock Bags • Advanced Poly-Bags™

| 1.5 mil     |              |            |               |              | 2 mil       |              |            |               |              |
|-------------|--------------|------------|---------------|--------------|-------------|--------------|------------|---------------|--------------|
| PART NUMBER | SIZE (W X L) | BAGS /ROLL | ROLLS /CARTON | BAGS /CARTON | PART NUMBER | SIZE (W X L) | BAGS /ROLL | ROLLS /CARTON | BAGS /CARTON |
| LD-0203     | 2x3          | 4500       | 20            | 90,000       | SD-0203     | 2x3          | 4000       | 20            | 80,000       |
| LD-0204     | 2x4          | 4000       | 20            | 80,000       | SD-0204     | 2x4          | 3000       | 20            | 60,000       |
| LD-0303     | 3x3          | 4500       | 14            | 63,000       | SD-0205     | 2x5          | 2250       | 20            | 45,000       |
| LD-0304     | 3x4          | 4000       | 14            | 56,000       | SD-0303     | 3x3          | 4000       | 14            | 56,000       |
| LD-0305     | 3x5          | 3000       | 14            | 42,000       | SD-0304     | 3x4          | 3000       | 14            | 42,000       |
| LD-0306     | 3x6          | 2500       | 14            | 35,000       | SD-0305     | 3x5          | 2250       | 14            | 31,500       |
| LD-0404     | 4x4          | 4000       | 10            | 40,000       | SD-0306     | 3x6          | 2000       | 14            | 28,000       |
| LD-0405     | 4x5          | 3000       | 10            | 30,000       | SD-0404     | 4x4          | 3000       | 10            | 30,000       |
| LD-0406     | 4x6          | 2500       | 10            | 25,000       | SD-0405     | 4x5          | 2250       | 14            | 31,500       |
| LD-0407     | 4x7          | 2000       | 10            | 20,000       | SD-0406     | 4x6          | 2000       | 10            | 20,000       |
| LD-0408     | 4x8          | 1750       | 10            | 17,500       | SD-0408     | 4x8          | 1500       | 10            | 15,000       |
| LD-0505     | 5x5          | 3000       | 8             | 24,000       | SD-0505     | 5x5          | 2250       | 8             | 18,000       |
| LD-0506     | 5x6          | 2500       | 8             | 20,000       | SD-0506     | 5x6          | 2000       | 8             | 16,000       |
| LD-0507     | 5x7          | 2000       | 8             | 16,000       | SD-0507     | 5x7          | 1750       | 8             | 14,000       |
| LD-0508     | 5x8          | 1750       | 8             | 14,000       | SD-0508     | 5x8          | 1500       | 8             | 12,000       |
| LD-0606     | 6x6          | 2500       | 6             | 15,000       | SD-0510     | 5x10         | 1250       | 8             | 10,000       |
| LD-0607     | 6x7          | 2000       | 6             | 12,000       | SD-0606     | 6x6          | 2000       | 6             | 12,000       |
| LD-0608     | 6x8          | 1750       | 6             | 10,500       | SD-0608     | 6x8          | 1500       | 6             | 9,000        |
| LD-0609     | 6x9          | 1500       | 6             | 9,000        | SD-0610     | 6x10         | 1250       | 6             | 7,500        |
| LD-0810     | 8x10         | 1500       | 4             | 6,000        | SD-0708     | 7x8          | 1500       | 6             | 9,000        |
| LD-09125    | 9x12.5       | 1250       | 4             | 5,000        | SD-0810     | 8x10         | 1250       | 4             | 5,000        |
|             |              |            |               |              | SD-09125    | 9x12.5       | 1000       | 4             | 4,000        |

| 3 mil       |              |            |               |              | 4 mil       |              |            |               |              |
|-------------|--------------|------------|---------------|--------------|-------------|--------------|------------|---------------|--------------|
| PART NUMBER | SIZE (W X L) | BAGS /ROLL | ROLLS /CARTON | BAGS /CARTON | PART NUMBER | SIZE (W X L) | BAGS /ROLL | ROLLS /CARTON | BAGS /CARTON |
| HD-0303     | 3x3          | 3000       | 14            | 42,000       | EHD-0304    | 3x4          | 1500       | 14            | 21,000       |
| HD-0304     | 3x4          | 2000       | 14            | 28,000       | EHD-0305    | 3x5          | 1250       | 14            | 17,500       |
| HD-0305     | 3x5          | 1500       | 14            | 21,000       | EHD-0404    | 4x4          | 1500       | 10            | 15,000       |
| HD-0306     | 3x6          | 1500       | 14            | 21,000       | EHD-0406    | 4x6          | 1000       | 10            | 10,000       |
| HD-0404     | 4x4          | 2000       | 10            | 20,000       | EHD-0507    | 5x7          | 1000       | 8             | 8,000        |
| HD-0405     | 4x5          | 1500       | 10            | 15,000       | EHD-0607    | 6x7          | 1000       | 6             | 6,000        |
| HD-0406     | 4x6          | 1500       | 10            | 15,000       | EHD-0608    | 6x8          | 750        | 6             | 6,000        |
| HD-0505     | 5x5          | 1500       | 8             | 12,000       | EHD-0610    | 6x10         | 500        | 6             | 3,000        |
| HD-0506     | 5x6          | 1500       | 8             | 12,000       | EHD-0708    | 7x8          | 750        | 6             | 4,500        |
| HD-0507     | 5x7          | 1250       | 8             | 10,000       | EHD-0710    | 7x10         | 500        | 6             | 3,000        |
| HD-0508     | 5x8          | 1000       | 8             | 8,000        | EHD-0810    | 8x10         | 500        | 4             | 2,000        |
| HD-0509     | 5x9          | 1000       | 8             | 8,000        | EHD-0910    | 9x10         | 500        | 4             | 2,000        |
| HD-0606     | 6x6          | 1500       | 6             | 9,000        | EHD-09125   | 9x12.5       | 500        | 4             | 2,000        |
| HD-0607     | 6x7          | 1250       | 6             | 7,500        | EHD-1012    | 10x12        | 500        | 4             | 2,000        |
| HD-0608     | 6x8          | 1000       | 6             | 6,000        |             |              |            |               |              |
| HD-0708     | 7x8          | 1000       | 6             | 6,000        |             |              |            |               |              |
| HD-0810     | 8x10         | 750        | 4             | 3,000        |             |              |            |               |              |
| HD-09125    | 9x12.5       | 600        | 4             | 2,400        |             |              |            |               |              |

| CLEAR/WHITE COMBO - 2 mil |              |            |               |              | SHOP TOWEL BAGS |              |           |             |               |              |
|---------------------------|--------------|------------|---------------|--------------|-----------------|--------------|-----------|-------------|---------------|--------------|
| PART NUMBER               | SIZE (W X L) | BAGS /ROLL | ROLLS /CARTON | BAGS /CARTON | PART NUMBER     | SIZE (W X L) | MIL THICK | BAGS /ROLL  | ROLLS /PALLET | BAGS /PALLET |
| SBSD-0305WC               | 3x5          | 2250       | 14            | 31,500       | 11421-41        | 15x32        | 1.25      | 625         | 48            | 30,000       |
| SBSD-0406WC               | 4x6          | 2000       | 10            | 20,000       | 11421-61        | 15x32        | 1         | 625         | 48            | 30,000       |
| SBSD-0507WC               | 5x7          | 1750       | 8             | 14,000       | 11421-67        | 15x32        | 1.25      | 1,500 (BOX) | 20 (BOXES)    | 30,000       |
| SBSD-0608WC               | 6x8          | 1500       | 6             | 9,000        | 11421-72        | 15x32        | 1         | 1,500 (BOX) | 20 (BOXES)    | 30,000       |
| SBSD-0810WC               | 8x10         | 1250       | 4             | 5,000        |                 |              |           |             |               |              |

# Specialty Films









Our extensive product line provides you with single-source convenience for all polyethylene, co-extruded and polypropylene grade films, blown or cast.

## Films for all products

Anticipating your needs for tomorrow, we are continually testing new products and modifying existing ones to achieve the properties you require. Trial orders are always provided for the end-use testing in your facility.

Let our technical sales staff demonstrate their problem solving assistance by helping you select the right film for your product. Call toll free: 1-800-754-4403.

## Standard Available Films

| Film No. | General Description  | Thickness Available | Specifications & Characteristics  | Applications   | Advantages   |
|----------|--|---------------------|---|--|--|
| 1        |  Linear Low / Low Density Blend (LDPE/LLDPE)    | 1-5 mil             | Strong, industrial clarity film<br>Note: May contain low levels of reprocessed materials. | Stock bags, heavy products (fasteners), FDA, General bagging                   | Down gauge from LDPE, tear/cut resistant, strong seals   |
| 2        |  High Clarity, LDPE w/EVA                       | 1-4 mil             | Retail clarity LDPE, virgin grade   | Retail printed bags, freezer applications, FDA, medical                        | Enhances product, higher gloss levels  |
| 4        |  100% Degradable                               | 1-5 mil             | Maintains strength & durability of traditional films                                      | All "Green" applications   | Fully degradable to satisfy "Green" initiatives  |
| 5        |  Opaque (or tinted) / Clear LLDPE Combination | 1-5 mil             | White (or other color) opaque or tinted on one side/clear on other side, virgin grade     | Thermal printing, barcoding, FDA, medical                                      | Lower cost than printed bags, larger print area for thermal printing, extended print head life |
| 6        |  High Density Polyethylene (HDPE)             | 1-2 mil             | Stiff, strong film, higher haze levels, natural, virgin grade                             | Non-scratch products (silverware, lenses, or noncoated plastics), FDA, medical | Natural high slip surface, down-gauge from LDPE  |
| 7        |  Non-scratch (LDPE)                           | 1-4 mil             | Retail clarity  | Lenses, silverware, cutlery, delicate pieces                                   | Decreased product marring or scratching  |
| 8        |  Opaque, (LDPE)                               | 1-5 mil             | White opaque film front and back, virgin grade  | FDA  | Thermal printing   |
| 9        |  Tinted, (LDPE)                               | 1-5 mil             | Color tinted film, virgin grade   | FDA  | Lower cost than printed bags, larger print area for thermal printing, extended print head life |

*Data sheets available upon request.*

















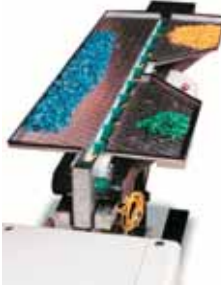





















## Standard Available Films from Advanced Poly-Packaging, Inc.

| Film No. | General Description   | Thickness Available | Specifications & Characteristics   | Applications   | Advantages  |
|----------|---|---------------------|--|--|---|
| 10       |  Antistat, Clear                 | 1.5-4 mil           | Clean/Dry (non-greasy) clarity dependent upon concentrate level  | Dust control, static control, electronic components dusting products, sand, filler materials | Printable antistat, nonirritant, mil spec. requirements met                               |
| 11       |  Antistat, Tinted (Pink or Blue) | 1.5-4 mil           | Clean/Dry (non-greasy) clarity dependent upon concentrate level  | Dust control, static control, electronic components dusting products, sand, filler materials | Tint helps identify antistat, easy contrast from clear polyethylene bags                  |
| 12       |  High Strength LLDPE             | 1.5-4 mil           | Stronger, higher productivity  | Heavy products, larger bag volumes, sharp products   | Linear low density blended films, heavy products, improved dart impact, and tear strength |
| 13       |  VCI                             | 2-4 mil             | Non-greasy VCI, Strong film  | Rust/corrosion inhibitor, bearings fasteners, firearms                                       | Long shelf life, clean & dry  |
| 16       |  Tyvek/Polyester combination    | Varies              | Type 1: A732-1073B uncoated, heat sealed to 48g polyester /2 mil polyethylene<br>Type 2: A5920-1059 B uncoated, heat sealed to 48g polyester /2 mil polyethylene | Medical, sterilization   | Wide chevron seals, peel, tear  |
| 17       |  Repro LLDPE                   | 1-5 mil             | Higher haze level  | General purpose industrial   | Environmental, reduced cost film  |
| 20       |  Cast Polypropylene (CPP)      | 1-3 mil             | Outstanding clarity, strong film, brittle/crisp high gloss, barrier properties: WVTR; .4, OTR 130  | Candy, wreaths, retail products, FDA, medical, novelty items                                 | Excellent clarity, stronger seals, printable, low haze, high gloss                        |
| 21       |  High Barrier Film             | 1.5-4 mil           | Strong film moisture, chemical and aroma barrier: WVTR; .4, OTR; 7.5 5 layers and 9 layers   | Silverware, coffee, chocolate, migrating chemicals, aroma emitting products                  | Excellent impact strength, good clarity, good barrier, long shelf life                    |
| 23       |  LLDPE/EVOH                    | 1.5-4.9 mil         | Superior oxygen and barrier: WVTR; .18, OTR; .05   | Laminators   | Superior oxygen barriers, optical properties, flat film caliper                           |
| 24       |  Mailer Film                   | 2.5 mil             | White/Gray   | Mail Pouches   | Used on automatic bagging equipment   |

# Industries • Products • Solutions

Here are a few examples of bagging machines or systems that are often used for some general product categories. The list is not comprehensive! Tell us about your application and our staff can determine the correct match for your product!

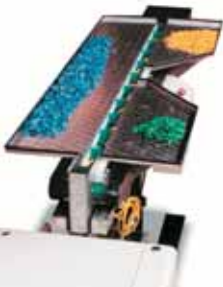
| Fasteners/Hardware/Automotive  | Kits   | Promotional/Crafts/Misc.  |
|--|--|---|
| Screws, hinges, nuts, washers, anchors, oil filters, injection mold products...      | Spare parts, plastic building blocks, game pieces...                                 | Pens, magazines, note pads, pocket knives, bullets, manuals...                        |
|     |    |    |
| Page 12  | Page 15  | Page 14   |
|     |    |    |
| Page 29  | Page 40  | page 29   |
|   |  |  |
| Page 14  | Page 26  | Page 24   |
|   |  |  |
| Page 35  | Page 24  | Page 13   |
|   |  |  |
| Page 28  | Page 27  | Page 11   |
|  | Page 25  |   |

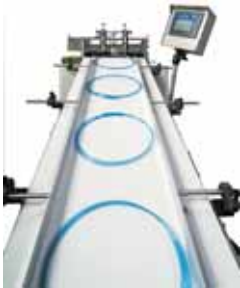
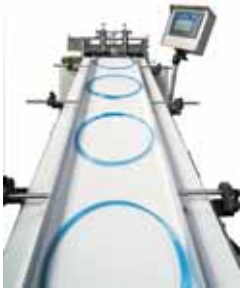
| Games/Jewelry/Cosmetic   | Foods   | Electronics   | Medical/Pharmaceutical  | Textile/Safety  |
|--|---|---|---|---|
| <p>Golf tees, lipsticks, batteries, precious metals, dice, necklace/bracelets...</p> | <p>Baked goods, lollipops, beef jerky, jelly beans, dog food, tortillas...</p>      | <p>Phone cases, computer wires, phone wires, computer parts...</p>                  | <p>Medical tubing, syringes, mail order Rx, surgical tools, baby bottles...</p>       | <p>Shop/microfiber towels, mop heads, lab coats, safety goggles, hard hats...</p>     |
|      |    |    |    |    |
| <p>Page 28</p>   | <p>Page 14</p>  | <p>Page 13</p>  | <p>Page 22</p>  | <p>Page 13</p>  |
|     |    |    |    |    |
| <p>Page 14</p>   | <p>Page 30</p>  | <p>Page 14</p>  | <p>Page 14</p>  | <p>Page 42</p>  |
|   |  |  |  |  |
| <p>Page 12</p>   | <p>Page 32</p>  | <p>Page 27</p>  | <p>Page 13</p>  | <p>Page 20</p>  |
|   |  |  |  |  |
| <p>Page 31</p>   | <p>Page 21</p>  | <p>Page 16</p>  | <p>Page 14</p>  | <p>Page 14</p>  |
|   |  |  |  |  |
| <p>Page 26</p>   | <p>Page 40</p>  | <p>Page 24</p>  | <p>Page 21</p>  | <p>Page 21</p>  |

## Tabletop Baggers

# T-200 Tabletop Bagger/Sealer

Throw away your hand sealer because Advanced Poly-Packaging's T-200 Tabletop Bagger/Sealer will dramatically increase production and decrease packaging costs while simplifying the bagging operation.

Package anything from fasteners, electronic components, literature, and manuals, to various foods, jewelry, and craft items!

The T-200 uses our Pre-Opened Bags on Rolls. Simply pull the bag into the loading and sealing position to allow the bag to blow open. Insert the product and press a foot-switch or guard-switch to seal the bag. It's just that simple and quick!



### Special Features:

- Dwell time and heat controls.
- Heat/dwell & cool LED's indicate cycle operation of sealing mechanism.
- Patented Teflon Shield™ increases Teflon life ten fold - because the Teflon is only in contact with the heating element while sealing, the element stays clean and delivers a long service life.
- Tilting guard (Guard-switch) cycles machine at the loading area, maximizing output and minimizing operator fatigue.
- Patented anti-jamming method ensures no attempts are made to seal obstructions in the seal area.
- Universal funnel attachment is standard allowing the operator to slide product directly into the bag.
- Adjustable volume air knife filters a continuous stream of clean air with a 4-micron filter.
- Adjustable load shelf supports the bag and assists the operator to position the bag at the proper seal point.
- Quick roll change assembly and easy threading allows operators to replace the roll of bags in less than a minute.

# T-275 Automatic Tabletop Bagger

Add automation with the T-275 Automatic Tabletop Bagger to increase packaging speed. This machine operates exactly like the T-200, but the machine automatically and quickly feeds the bag into the loading/sealing position and blows it open before you insert the product. It is a good choice for lower-volume packaging of a wide variety of products.

**Special Features:**

- Auto or Manual operation
- Total cycle counter
- Seal time
- Fill time delay
- Seal point
- Saves data for automatic recall when power is shut off



**Specifications**

| Description                     | T-200                          | T-275                          |
|---------------------------------|--------------------------------|--------------------------------|
| Bag feed method                 | Manual registration            | Automatic registration         |
| Seal mechanism                  | Solid heater bar               | Solid heater bar               |
| Cycle operation                 | Semi-automatic                 | Automatic                      |
| Bag size range (10" dia. rolls) | 2" x 3" up to 11" x 16"        | 2" x 3" up to 11" x 16"        |
| Film thickness                  | 1 to 5 mil                     | 1 to 5 mil                     |
| Estimated packaging speed       | 5 to 15 bags per minute        | 10 to 30 bags per minute       |
| Guard-switch feature            | Standard                       | Standard                       |
| Auto/Paced rate operation       | Standard                       | Standard                       |
| Anti-jam seal bar               | Standard safety feature        | Standard safety feature        |
| Electric                        | 110V/60hz (220V/230V, 50/60hz) | 110V/60hz (220V/230V, 50/60hz) |
| Air                             | .5 cfm/40psi                   | .5 cfm/40psi                   |
| Dimensions                      | 19-1/2" x 16" x 21-1/2"        | 19-1/2" x 16" x 21-1/2"        |
| Weight                          | 50 lbs.                        | 60 lbs.                        |

# T-300 Automatic Tabletop Bagger

Our smallest, fully automatic bagger offers increased production capabilities. We pack a lot of features into this bagger, including touch-screen operation, “pop-up” messaging, job save/recall and automatic/paced operation.

Automatic indexing, sealing, tear-off or continuous strips of bags are possible.

Available options include the BF-10 Bag Deflator, CF-10 Counting Funnel, CS-10 Compartment Seal, LS-10/LS-15 Load Shelves, BL-10 Blow Off Assembly, Hand Scanners, Stainless Steel Funnels and Height-Adjustable Cart with Quick Change Bag Bars (shown below).



**Height-Adjustable Cart**

#### **T-300 & T-375 Special Features:**

- Full color screen with pop-up windows
- Diagnostic and troubleshooting screens
- Preset and totalizing bag counter
- Automatic “paced” operation with fill time delay timer
- Universal, adjustable parts chute
- Adjustable support shelf
- Blower with flow controls
- One year limited parts warranty

# T-375 Automatic Tabletop Bagger/Printer

## “Next Bag Out”

In addition to all the features of the T-300, the T-375 incorporates a thermal transfer printer for “Next-Bag-Out” printing. This patented feature allows for printing just prior to loading, which guarantees accurate labeling and allows for quick changeovers on even the smallest batches. The seamless transition is also perfect for pharmaceutical applications when accurate labeling is vital.



| 2" Connection Fittings  |   |
|---|---|
| PN: 991462  | Manufactured In:<br>Akron, OH   |
| <ul style="list-style-type: none"> <li>✓ Certified</li> <li>✓ Tested</li> <li>✓ Approved</li> </ul> | <br>991462 |



Actual Bag Samples



### Specifications

|  |   |                                  |
|--|---|----------------------------------|
| Description                              | T-300/T-375                                     |                                  |
| Seal mechanism                           | 1/8" Solid heater bar (thermocouple controlled) |                                  |
| Cycle operation                          | Manual/Automatic                                |                                  |
| Guard-switch feature                     | Standard  |                                  |
| Product pass-through                     | 3" (can be increased)                           |                                  |
| Electric                                 | 110V/60hz (220V/230V, 50/60hz)                  |                                  |
| Dimensions                               | 22" wide x 20" deep x 22" high                  |                                  |
|  | T-300   | T-375                            |
| Cycle rate                               | Up to 50 bags per minute                        | Up to 30 bags per minute         |
| Bag size range                           | 2" x 2" up to 11" x 16"                         | 2" x 3" up to 11" x 16"          |
| Index speed                              | 25" per second                                  | 12" per second (with printer on) |
| Air*                                     | 50psi   | 60psi                            |
| Weight                                   | 110 lbs   | 125 lbs                          |
| * An "air-free" model is also available. |   |                                  |

**T-375 Printer Specifications:**  
 Zebra 110Xi IV Series Printer, 203 dpi  
 305 dpi and 600 dpi, optional  
 4" x 12" print area or 5" x 12", optional  
 Built in memory for storage (999 labels)  
 16 MB SDRAM; 8 MB non-volatile Flash memory

# T-1000 Advanced Poly-Bagger™

Because the list of applications for this bagger is endless, it is not surprising that this is our best selling machine. The T-1000 is designed for virtually any non-liquid products, including fasteners, hardware, injection mold parts, kits, crafts, most non-powdered foods, medical devices and more!

In addition to the most basic model, shown below, we offer many configurations of the T-1000 described on the pages that follow. Patented "Next Bag Out" printing is available.

T-1000 Wide model available.



## Specifications

|                      |                           |
|----------------------|---------------------------|
| Description          | T-1000 Bagger             |
| Style                | Vertical                  |
| Cycle Operation      | Automatic/Manual          |
| Weight               | 300 lbs.                  |
| Footprint            | 47" x 36" x 36"           |
| Frame Configuration  | Drop Frame (4.5)          |
| Cycle Rate           | up to 100 bags per minute |
| Bag Size Range       | 2" x 3" to 14" x 30"      |
| Product Pass Through | 4" – 7"                   |
| Load Height          | 34" – 42"                 |
| Seal Bar             | 14" x 1/8"                |
| Electric             | 110/220V, 60/50 Hz        |
| Air                  | 60 psi                    |

**See T-1000 Options  
& Accessories on  
pages 16-19**



# Configuration Samples

The T-1000 Advanced Poly-Bagger™ can be configured for various types of applications. You can benefit from the engineering of our most popular bagger, but with the advantage of the machine being configured to better fit your needs. Check out some of the most popular T-1000 configurations:



Standard T-1000 with basic Printer Option & Partition Table



The T-1000 with Height Configuration

See more configurations, pp. 20-21

## Special Features

- Touch Screen Interface Panel: The fully-adjustable, user-friendly panel controls operation of the bagger or all system components; pop-up troubleshooting screens identify operation messages and occasional fault conditions; technical assistance screens provide access to INPUT/OUTPUT IO without removing covers.



- Recipe Management: With optional intranet connection for back-up or production management.
- Teflon Shield™: This patented feature extends Teflon life up to 10 times standard sealers by keeping it away from the heater when not sealing.
- Energy Conservation and Component Saver: Components not being used are turned off to save energy, extending the life of those components.
- Anti-Jam Device: Detects obstructions in the seal area, automatically reverses the pressure bar and stops the cycle operation.
- Counters: 1) Preset Counter - allows bagger to stop when predetermined count is reached. 2) Totalling Counter - reset this counter each shift or each day to record packaging over a period of time. 3) Continuous Strip Counter - set the number of bags not separated at the perforation to feed in a continuous strip. 4) Maintenance Counter - total machine cycle counter for preventative maintenance/component inspection intervals.

## T-1000 Options & Accessories

# Ti-1000Z Inline Thermal Transfer Printer

The latest in print head technology! The printer incorporates Zebra's latest Higher Performance series print engine. The printer is perfectly integrated into the bagging operation with touch screen control over the entire bagging and printing system. It has the graphic capability to print bar codes, text, lines, logos and other custom graphics directly on the poly bag.



Shown here with our T-1000



### Special Features:

- Prints up to 12" per second (10" max suggested for printing on poly bags)
- Format labels up to 4" x 12" at 203dpi
- Fixed data label save/recall option (no PC required)
- Flexible connectivity, including simultaneous Ethernet, USB or Parallel connections

### Available Options:

- 300 & 600 dpi print head upgrade
- Print head element out feature
- ZebraNet Wireless Plus Print Server (with radio card)
- ZebraNet Internal Print Server 10/100 Ethernet connection
- 64MB Flash memory with ZPL II & XML
- 64MB main logic board upgrade
- SP-10 Spare Parts Kit
- RAP print registration, film accumulator for increased production

### Specifications:

- 15" Web pass-through
- 16 MB SDRAM, 8 MB Flash memory
- ZPL, ZPL II & XML programming languages
- "Ribbon Out" & "Bag Out" photo sensors
- USB 2.0 port, high speed bi-directional IEEE 1284 parallel interface
- Mounting brackets, interface cables, regulator, 10' printer cable (USB), operation/parts manual, one year limited parts warranty (60 day print head warranty).

## Printer Accessories



**Ribbons and Labels:** Ribbon in stock for most APPI printers in addition to Datamax, TEC, Zebra, APS, Comstar, Geo and more. Our thermal transfer printer ribbon is specifically engineered to print to Pre-Opened Advanced Poly-Bags on Rolls and other roll stock.



**Barcode Verifiers:** Choose from pen-style or portable desktop verifiers. Randomly inspect quality or command a detailed analysis. Printer available for hardcopy record of test results.

# T-1000 Options & Accessories

Although the T-1000 is extensively equipped with a multitude of standard features, a full range of auxiliary options and equipment can easily be added for special purpose packaging or to improve your packaging operation:



**Funnels, Standard and Custom:** Order funnels that are in stock at all times with sizes ranging from a 1" opening to a 7" opening. Custom funnels are also provided to facilitate loading. Having the proper funnel and bag size for your product is very crucial to an efficient operation.

**Funnel Kit:** Purchase all funnel sizes (13 total) for the price of 10 funnels. Quick release knobs allow instant funnel changeovers.



AF-10

**AF-10 Accumulating Funnel:** Pneumatic gate increases the speed of automatic operations by "staging" the product immediately above the bag opening. When the bag is ready to receive the product, the gate opens, enters the bag, and maintains the bag opening to reduce product spills.



CF-10

**CF-10 Counting Funnel:** Add a photo array to the AF-10 funnel for inline bagging operations. Counts product as it enters the funnel; pneumatic funnel causes separation between counts for continuous feed operations.



LS-10

**LS-10 Load / Support Shelf:** Supports the bottom/back of bag during loading of heavier or bulkier products. Pneumatically operated, adjustable shelf provides support and takes the initial impact of heavier products dropping into the bag. Shelf tilts downward after sealing, dropping product from shelf. Various length for longer bag sizes.

**LSV-10 Vibratory Shelf Attachment:** "Taps" the bag to settle product to the bottom of the bag. Pneumatic operation with speed controls. LS-10 option must be previously installed or purchased with the vibratory shelf attachment.



LC-10

**LC-10 Light Safety Curtain:** An OSHA approved safety device that restricts the cycle operation of the bagger when the optical detection field is obstructed. LC-10 option is recommended when the funnel is removed and the product is loaded directly into the bag. Increase production by 40% by turning on the "auto" feature to cycle the bagger on the trailing edge of the light curtain input signal. Lockout key is provided to prohibit by-passing this safety feature. Excellent option for hand loading operations.

## T-1000 Options & Accessories *continued*

DF-10



**DF-10 Diverting Funnel/Bag Counting Option:** As finished bags are sealed and dropped from your bagger, they can be counted and redirected at the end of each preset count. With a two box system, the bags are directed into “box A” until the final count is reached. Then the diverter rotates, directing the bags into box B allowing the operator time to remove, seal and replace box A. Includes diverting/rotating attachment, photo array, brackets and counter controls. (UF-2000 Incline Conveyor sold separately.)

PT-10



**PT-10 Small Partition Table (36” wide):** Stainless steel partitioned utility table keeps products separated for manual kit packaging. Adjustable tilt and height with up to five compartments.

**PT-20 Medium Partition Table (48” wide):** Stainless steel partitioned utility table with up to six compartments.

**PT-30 Large Partition Table with Stand (60” wide):** Stainless steel partitioned utility table with up to eight compartments.

LB-10

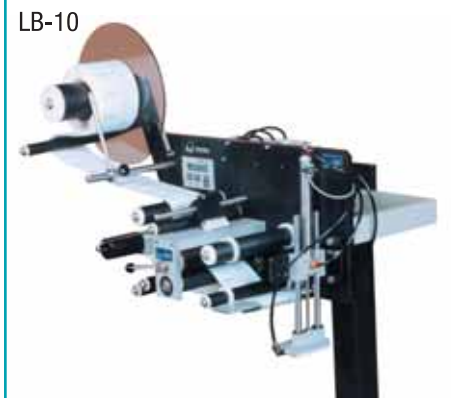

**LB-10 Label Applicator Attachment:** Apply preprinted labels inline while bagging. Labels are accurately dispensed onto the bag from an air vacuum grid with +/-1/32” dispensing accuracy. Also Print and Apply labels with our thermal transfer printer/label applicator. Print up to 305 dpi on labels from 1/2” x 1/2” up to 4” x 6”.

**LB-20 Print & Apply Label Applicator Attachment:** Print on demand and apply labels up to 5” x 6” to the bag.

Further specifications available upon request.

BO-30

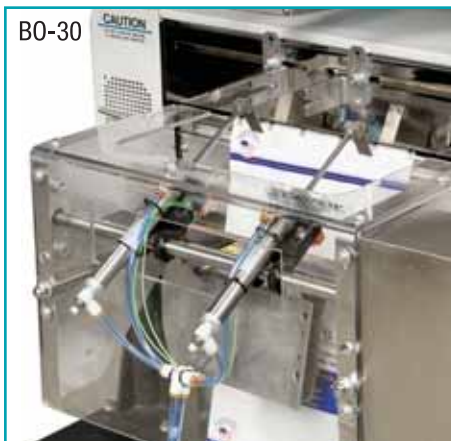

**BO-30 Bag Opening Device:** The most reliable way to make sure your bag is in position and ready to receive product!

- Validates opening to save product
- Larger opening than with air to force a wider, more consistent opening

**BO-30A Adjustable Bag Opening Device:** The same features as the standard model, but also offers adjustable width and depth – no tooling required for quick bag size changes.



PB-20

**PB-20 Dual Optical Palm Buttons:** OSHA-approved safety device. Two optical “no-touch” buttons must be pressed simultaneously to initiate the cycle operation of the bagger. If the two sensors are not pressed at the same time, the bagger will not cycle, ensuring that fingers or hands cannot be in the seal area. Recommended when no funnel is present.



SP-10

**SP-10 Level 1 Spare Parts Kit:** Kit contains day to day normal wear items. Teflon, filter, fuses, seal rubber, and heater cartridges identifies some items in the kit.

**SP-20 Level 2 Spare Parts Kit:** Additional items not projected to fail but due to the cost of lost production, are required to prevent down time. Valves, cylinders, circuit boards, and a touch screen are some of the items included in this kit.

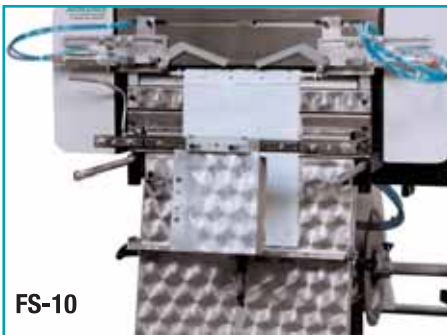

FS-10

**FS-10 Flat Seal Assembly:** Decreases the possibility of wrinkles in the seal area while increasing seal integrity. Pneumatically operated opposing “fingers” pull each side of bag taught above the seal area to flatten the seal area.

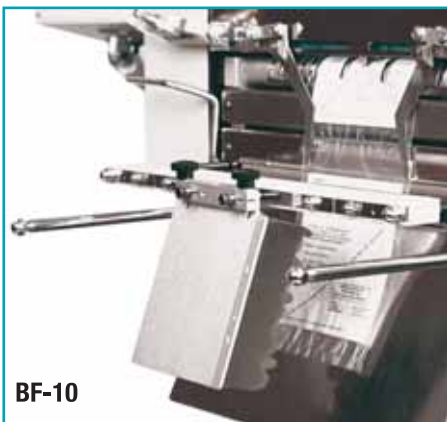

BF-10

**BF-10 Bag Deflator:** Removes excess air from the bag. Sponge or rubber loop deflators push the air out just prior to sealing.



BV-10

**BV-10 Barcode Verifier:** Verifies that barcodes on preprinted or thermally printed bags are readable and stops the cycle operation when a non-readable barcode is detected.

## More T-1000 Options:

**AD-10 Point of Use Air Dryer:** Filter 99% of liquids from your plant air with this dryer component. Liquids are then automatically drained before entering the pneumatic system increasing component life.

**BO-10 Bag “Out” Sensor:** Detects the last bag off the roll and shuts down the bagger, while alerting the operator of the fault condition.

**BO-20 Bag “Open” Sensor:** (AF-10 Funnel required.) Detects whether the bag has properly blown open prior to the product entering the bag.

**CS-10 Compartment Seal Option:** Separate two products in one bag by creating a seal between two compartments. After the first product is loaded, press the foot switch to seal the first product in the bag. Then load the second product, and press the foot switch to index the bag and seal the bag a second time above the second product. The bag is then detached and another bag is indexed into the loading position.

**IF-10 Insert Funnel:** For products affected by air flow, an insert funnel provides a solution. After the bag has been blown open, the funnel enters the bag, holding it open so air can be decreased or shut off. The funnel enters past the seal area decreasing the potential of seal contamination. Ideal for granular type products.

**OFS-10 Output Fault Signal Option:** Signal is provided to advise third party equipment that a fault condition (i.e.: out of bags, jam detection, printer error) is present on the T-1000 bagger and to cease production operations. Audible or visual signals can also be provided to alert the operator.

**QC-10 Quick Roll Change Option:** Additional roll shaft and roll chucks. By having a full roll shafted, the operator can perform roll changes quickly and immediately when the bagger is out of bags.

**TS-10 Trim Seal Assembly:** Trims excess film from bag above seal to enhance the appearance of the package (retail products).

**TW-10 Twin-Seal Option:** Automatically seals the bag a second time, 3/4” from the first seal to increase bag integrity.

## Special Purpose Configurations

# Horizontal Advanced Poly-Bagger™

The size, shape or consistency of some products make them difficult to package with a traditional bagging machine. The T-1000 Horizontal and Wide Horizontal models are engineered for those purposes.

Our options allow you to either manually slide the product into the bag, or allow an infeed conveyor to do the work for you! After the product enters the bag, the bagger seals the bag and automatically discharges the package onto a takeaway conveyor. Simultaneously, the next bag is indexed into position, blown open and ready to receive the next product.

T-1000H Wide model available.



Some recent applications include ball caps, hard hats, clothing/uniforms, breads/baked goods, coiled rope/hosing/cable, gasket kits, towels/sheets and filters and kits with instructions.



Kitty uses an infeed conveyor to package plastic mats (left) and pita bread (right).



Kyle is using a custom stainless steel loading shelf to package products in a medical clean room.



Debbie is packaging hard hats with an infeed conveyor.



Bulky or lightweight products are difficult to package in a traditional, vertical bagger. Davida manually slides product (spongest) toward an open bag.

# T-1000 Medical Tyvek® Bagger

The T-1000 Medical Bagger incorporates all the features of the T-1000, plus meets all requirements for clean room use and medical validation, including seal/dwell time, pressure and temperature. This bagger seals Tyvek® pouches on rolls, with 1/4" peel-tear seals.



## Special Features:

- 3/8" constant heat seal bar.
- Seals Tyvek®/polyester, polyethylene, foil laminates and other barrier films including HDPE, LDPE, LLDPE, Polypropylene and Nylon barrier films.
- Low pressure detector prohibits seal operation when pressure is below required levels.
- Low temperature detection prohibits seal operation when temperature is below programmed settings for medical validation of seal temperature.
- Stainless steel construction, non-corrosive components and oil-free operation provide clean room access of this bagging system.
- Equipped with 4 micron filter, air is filtered entering the bag.



Patented Tyvek®  
Pre-Opened Bags

Tyvek® is a registered trademark of E.I. du Pont de Numours and Company



# T-1000 Systems

The T-1000 Advanced Poly-Bagger™, whether standard or configured, does not always stand alone. It seamlessly integrates with our other machine components to become the nucleus of larger packaging systems. Most of our products materialized by talking to customers who needed a solution for a specific application. Take a look at some of our more popular T-1000 systems, then challenge our engineers to configure one of them or design a new one that will best fit your application!

## Semi Automatic Systems



US-5000 pg. 24



US-5500 pg. 25



UF-5000 pg. 26

## Automatic Systems



UC-2400 pg. 27



US-9000 pg. 28



UCS-2400 pg. 29



US-7000 pg. 30



US-8000 pg. 31

## Exit Systems



US-4000 pg. 32



US-6000 pg. 33



UF-2000/UF-3000 Series pg. 34-35

# US-5000 Semi-Automatic Net-Weigh/Counting Scale

When fast changeover is more important than automation, our US-5000 Scale is the solution. The US-5000 sets up in seconds, unlike automatic scales that typically require longer setups and are designed for longer runs. Just slide any “sample” quantity in the load tray, key in your quantity, press the count button and you're finished!



Shown here with T-1000  
Advanced Poly-Bagger



## Specifications

|   |                                   |
|---|-----------------------------------|
| Description:  | US-5000 Scale                     |
| Weight:   | 153 lbs.                          |
| Dimensions (footprint):   | 44" x 45" x 42"-62" (adj. height) |
| Load height:  | Adjustable, 38" to 49"            |
| Scale load tray:  | 4.5" x 10" x 4" height**          |
| Load cell:  | 5, 10, 25 or 50 lb.               |
| Accuracy:   | up to .001 lbs.                   |
| Electric:   | 110/220V, 60/50 Hz                |
| Air:  | 40 psi                            |
| Scale controller, Tabletop/Load tray, Discharge Funnel, Manual,<br>One Year Parts Warranty Included |                                   |
| **Tray can be larger to suit volume and size of product   |                                   |

## Special Features:

- A digital averaging program combined with 16,000,000 internal counts delivers high accuracy and stability.
- Variable sampling, automatic zeroing, keyboard calibration and multiple modes are all standard scale controller features.
- A large stainless steel table with side walls is provided to store or sort products for loading.
- All contact surfaces are stainless steel (optional wash down retrofit package available).
- Count readout up to 50,000 pieces or weight readout in pounds, kilograms or grams.
- Readout and weight update rate is 10 times per second.
- Integration-ready for the T-1000 Advanced Poly-Bagger.
- Need more product immediately available to the operator? Then add a vibratory bulk supply hopper with proximity or leveling switch to automatically refill the tabletop.

# US-5500 Net-Weigh/Counting Scale

Take kit packaging to a new level! The semi-automation that kit packagers demand has never been easier to use with the addition of partitions and LED lights on the traditional load table. The lights signal operators to feed kit components. When weights have been determined, the scale automatically feeds the bagger and initiates cycle operation according to preset programming.



Shown here with T-1000 Advanced Poly-Bagger and UF-2000 Incline Conveyor

## Special Features:

- Green LED lights indicate which part to load
- LED switches from bin to bin as piece quantity is met
- Up to six partitions, adjustable size
- Up to 10,000 pieces per part number
- Controlled by T-1000 Advanced Poly-Bagger™/ touch screen controller
- Recipe management with removable memory card and Microsoft Excel mgmt.

## Options:

- Flexible number of load cells
- Bulk hopper for larger storage capacity
- Barcode scanner to recall settings
- Various funnel sizes, chutes (easy to change)

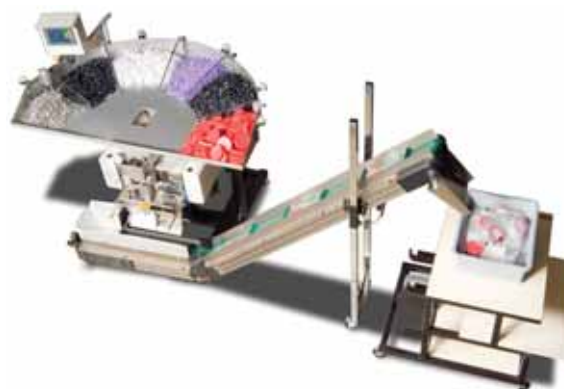

|                | <b>Specifications</b>                             |
|----------------|---|
| Description:   | US-5500 Net-Weigh/Counting Scale                  |
| Weight:        | 175 lbs. (scale only)                             |
| Dimensions:    | 35" W x 28" D                                     |
| Accuracy:      | Up to +/- .001 lbs. (.5 grams)                    |
| Speed:         | Up to 30 weights per minute<br>Operator Dependant |
| Load Height:   | Adjustable 36" to 46"                             |
| Load Cell:     | 5, 10 or 20 lbs.                                  |
| Load Capacity: | Up to 5 lbs. standard                             |
| Update Rate:   | Up to 10 times per second                         |
| Scale Opening: | 3.75" W x 6.25" D                                 |
| Electric:      | 110/220V, 60/50Hz                                 |

# UF-5000 Cleated Compartment Infeed Conveyor

Are you packaging Hardware kits, appliance kits, bicycle kits, toy assembly kits or craft kits? The UF-5000 allows you to set the production speed for guaranteed packaging results or set the pace rate for operators.

Your operator can use the UF-5000 to feed multiple compartments without interruption and without waiting for bags to be blown open or sealed.

## Special Features:

- Modes of Operation:
  - Manual – use the convenient foot switch
  - Continuous Feed – variable speed controls for paced rate
  - Automatic – indexes compartments signaled by batter, FFS machine, feeder or carton equipment; signal sent back to the package equipment after each compartment is indexed or product is detected in compartments
- “V” Track Belt Alignment – guarantees perfect tracking with no alignment and few tension adjustments.
- Castors – rugged castors allow for easy plant mobility.

## Options and Accessories:

- Special funnels, including accumulating funnels (can improve product flow)
- Various widths, lengths, compartment sizes/cleat heights available
- Vibratory bowl feeders, cartridge feeders or scales for automatic product feed
- Product sensor to detect product (eliminates wasted bags when compartments are empty)
- Stainless steel countertops for product storing and loading into compartments

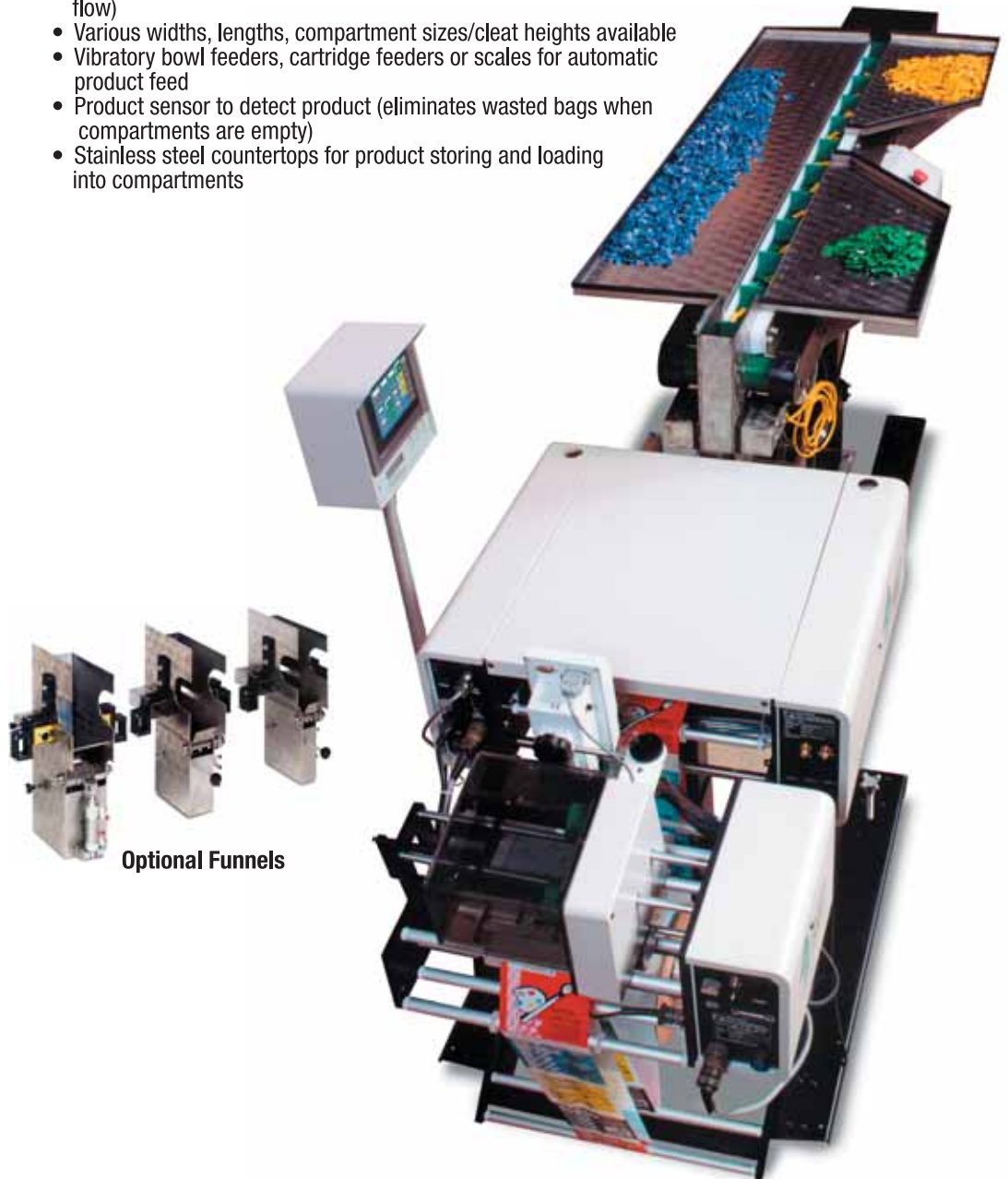

Optional Funnels

# Ultra Count Series Vibratory Parts Counters

(Standard Models UC-1400, 2400, 3000 & Custom)

Whether bagging fasteners, hardware, electronics or other components, the Ultra Count Series counters provide the flexibility and speed to get the job done accurately and quickly.

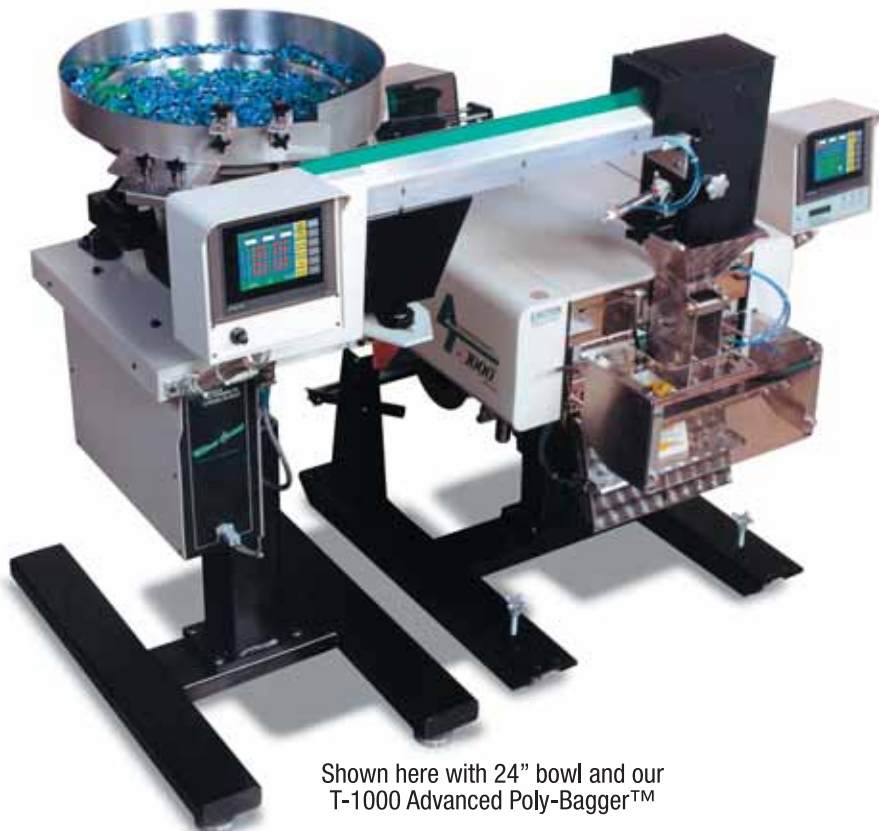

Shown here with 24" bowl and our  
T-1000 Advanced Poly-Bagger™



UC-2400 with optional hopper

## Special Features:

- Thick coated stainless steel bowls provide long life – even when running abrasive or sharp parts.
- “Drop gates” and “skivers” provide separation for accurate parts flow.
- Programmable, self-training photo eye to count only those parts that are within the set range of acceptance.
- Single or dual-accumulator for accurate separation and accumulation of parts.
- Rugged and heavy framework with “two-cushion” suspension for smooth and accurate parts flow.
- Standard fasteners can be recalled from a database for automatic eye and bowl setups.
- Integrated belt system.
- Transports product to bagger funnel.
- Assists in separating parts for accurate counts.
- Conveyor system automatically increases or decreases speed with the vibratory bowl for maximum production.
- Design allows bowl to set lower for easier filling (hopper feeders or Ultra-Feed Incline/Vibratory Hopper conveyors are optional)

## Specifications

|   |   |
|---|---|
| Weight  | Stand & 24" Bowl 750 lbs.; as shown 1,050 lbs.    |
| Dimensions (footprint)                                      | 5' x 3'   |
| Height (adjustable)   | 62" x 73"   |
| Supply Hopper Load Height                                   | approx. 65-75" inches                             |
| Bowl  | 14", 24", 30" or custom diameter, stainless steel |
| Feed direction  | Counterclockwise                                  |
| Bowl Coating  | Irathane (or no coating)                          |
| "V" Track Conveyor  | Variable speed, 2" wide, long or sort avail.      |
| Electric  | 110/220V, 60/50 Hz                                |
| FLC   | 10 amps   |
| Air   | 1.5 cfm, 80 psi                                   |
| Touch Screen, Supply Hopper                                 | Included  |
| Stand, Interface Cables, Manual,<br>One Year Parts Warranty |   |

# US-9000 Automatic Vibratory Bowl Net-Weigh/Counting Scale

The US-9000 is ideal for precision counting of parts that do not separate or run through a parts counter. Parts are fed at optimum speeds from a vibratory bowl feeder and are weighed in a scale accurate to .001 lb. Perfect for accuracy of lighter parts and smaller batches that cannot be counted on a typical net-weigh scale.

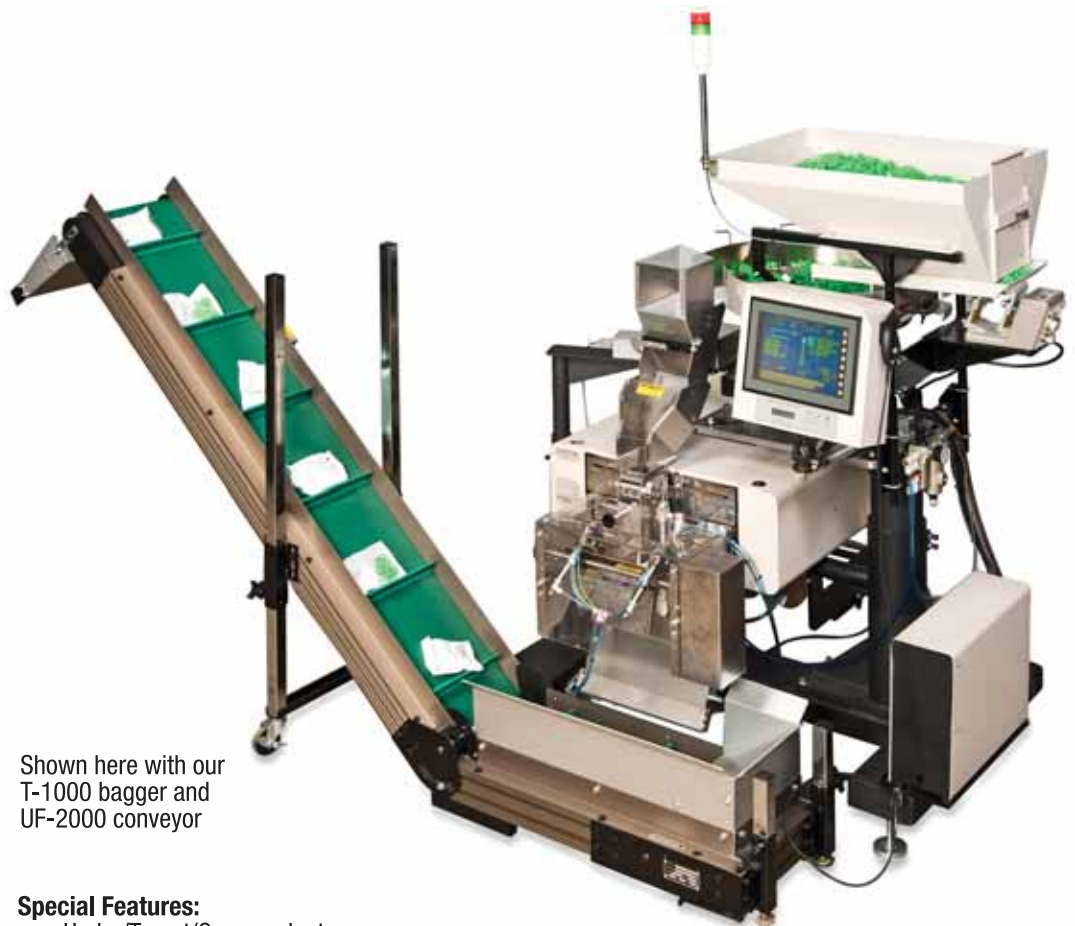

Shown here with our T-1000 bagger and UF-2000 conveyor

## Special Features:

- Under/Target/Over readouts.
- Integration-ready to the T-1000 Advanced Poly-Bagger.
- Vibratory supply hopper with leveling arm/switch is standard.
- Readout and weight update rate of 10 times per second.
- Parts slide out of tray in a stream to decrease product jamming in funnels.
- Overweight programming to halt system if out of the programmed weight range.
- 24" stainless steel, tooled bowl with slide gate and wipers to adjust product volume.
- Variable sampling, automatic zeroing, keyboard calibration are standard.
- Count readout up to 50,000 pieces, or weight readout in pounds, kilograms or grams.

## Specifications

|  |                                       |
|--|---------------------------------------|
| Description:   | US-9000 Vibratory Bowl Counting Scale |
| Weight:  | 1,100 lbs.                            |
| Dimensions (footprint):  | 54" x 48" x 54"                       |
| Supply Hopper Load Height:   | Adjustable to 55" - 72"               |
| Scale Load Tray:   | 4.5" x 10" x 4" height**              |
| Bowl Specs:  | 24" diameter, Stainless Steel         |
| Bowl Feed Direction  | Counterclockwise, Irtthane Coating    |
| Load cell:   | 10 kg                                 |
| Accuracy:  | up to .001 lb.                        |
| Electric:  | 110/220V, 60/50 Hz                    |
| Air:   | 40 psi                                |
| Scale controller, Stand, Load Tray, Discharge Funnel, Manual, One Year Parts Warranty Included |                                       |
| **Tray can be larger to suit volume and size of product  |                                       |

# UCS-2400 UltraCount Scale

This 3-in-1 system includes the following functions never before available in a single machine: 1) Vibratory Parts Counter, 2) Check-Weigh Scale and 3) Net-Weigh Counting Scale.



Functioning as a parts counter, the UCS-2400 performs to the same standard as our Model UC-2400 and includes: bulk supply hopper, high speed stainless steel bowl / drive, V-track belt for parts separation, high speed optical frame and accumulating/batch assembly.

Added check-weigh functionality now makes this an ideal solution for customers demanding perfect counts. After the batch count is complete, the scale weighs the batch and accepts or rejects the count. An Auto-Correct sequence is also available for undercount situations.

Alternative mode of net-weigh counting is also available for larger batch counts. Instead of feeding just one part through an eye, larger counts can be achieved quickly using the scale-only function. Bulk and dribble feed modes ensure accuracy since individual parts are fed as the final count is reached.

This multi-mode system is perfect for users who package in counts of one per bag or hundreds per bag. Recipe management allows for fast changeover from one mode to another, with minimal mechanical adjustments.

The UCS-2400 system complements our T-1000 Bagger as a complete solution for parts bagging.

|                        | <b>Specifications</b>                         |
|------------------------|---|
| Description:           | USC-2400 Check-Weigh Parts Counter            |
| Weight:                | 750 lbs.; as shown, 1,050 lbs.                |
| Dimensions:            | 5' x 3'                                       |
| Supply Hopper Load Ht: | 62"-73" (adjustable)                          |
| Bowl Specs:            | 24" diameter; urethane coating; cascade style |
| Bowl Feed Direction:   | Counterclockwise                              |
| Load Cell:             | 10g   |
| Accuracy:              | Up to .001 lbs.                               |
| Electric:              | 110V/60Hz                                     |
| FLC:                   | 1.5 amps                                      |
| Air:                   | 40psi   |

#### **Special Features:**

- Full color touch screen
- Job save/recall recipe settings
- Sampling/auto eye setup function
- Scrap parts filtering
- Auxiliary communications with networking capability
- Adjustable center post stand
- Settings to prevent overages

# US-7000 Automatic Net-Weigh, Single or Dual Head Scale

The US-7000 is an automatic feeding solution for fasteners, injection molded components, foods or any other bulk products. This net-weigh scale is accurate to .01 lbs. Double production with our dual scale head design or keep it simple with our single head scale.



Shown here with  
our T-1000 bagger

## Special Features:

- All stainless steel contact surfaces.
- Programmable bulk & dribble settings.
- Three tray vibratory feed system.
- Nema 4 enclosure, microprocessor based controls.
- Standard 2 cubic foot supply hopper.
- Discharge chute to suit bagger funnel opening.
- Pneumatic discharge mechanism.
- 400 cubic inch weigh capacity.
- Clam-type weigh bucket can instantly be removed for cleaning.
- Painted steel stand/support.

## Specifications

|  |  |
|--|--|
| Description:   | US-7000 Net Weigh Scale                |
| Heads available:   | 1 to 4                                 |
| Weight:  | 250 lbs. (higher for dual head+scales) |
| Dimensions (footprint):  | 28" x 30" x 26"-34" (adj. height)      |
| Supply Hopper Load Ht:   | Adjustable, 6' to 8'                   |
| Load cell:   | 10 lb., 25 lb. or 50 lb.               |
| Accuracy:  | up to .01 lbs.                         |
| Electric:  | 110/220V, 60/50 Hz                     |
| Air:   | 40 psi                                 |
| Scale Controller, Supply Hopper, Discharge Funnel, Manual, One Year<br>Parts Warranty Included |  |



# US-8000 Multi-Head Net-Weigh Scale

The US-8000 Multi-Head Net Weigh Scale offers unbelievable speed and accuracy. Fully automated weighing of just about any type of product! Amazing accuracy means you won't waste product! It's like having 8, 10 or 14 scales in one!



Shown here with the  
T-1000 Advanced Poly-Bagger  
and UF-3000 Incline Conveyor

## Special Features:

- Stainless Steel Construction
- Operated by Microprocessor
- Job Save/Recall
- Disassembly without tools for quick servicing
- Full Color Touch-Screen Interface
- 8, 10 & 14-Head Configurations

## Specifications

|                         |                           |
|-------------------------|---------------------------|
| Description:            | US-8000 Multi-Head Scale  |
| Weight:                 | 600 lbs. (scale only)     |
| Weight:                 | Approx 1100 lbs. complete |
| Weight Accuracy:        | 0.3 - 1g                  |
| Speed:                  | 60 bags per minute        |
| Load height (as shown): | 9' 3"                     |
| Footprint (as shown):   | 14.5' x 5' 2"             |
| Scale head max width:   | 45.2"                     |
| Electric:               | 110/220V, 60/50 Hz        |



# US-4000 Rotary Check-Weigh Scale

Ultra Scale for checking/weighing offers an exceptional performance for dependability and accuracy for all of your check-weighing applications. The rotary stepper-feed operation is designed for applications requiring faster check-weighing speeds.

The drum is designed to flip bagged product that meets programmed weight requirements to a waiting container or exit conveyor or flip the occasional rejected bag into a separate container, so finished product can be examined.



## Specifications

|   |                         |
|---|-------------------------|
| Description:  | US-4000 Rotary CW Scale |
| Weight:   | 250 lbs.                |
| Dimensions (footprint):   | 36" x 36" x 48"         |
| Load height:  | 42"                     |
| Load cell:  | 10 kg. Live weight      |
| Accuracy:   | up to .001 lbs.         |
| Electric:   | 110/220V, 60/50hz       |
| Air:  | 40 psi                  |
| Scale controller, Rotary Drum, Accumulating Funnel, Manual,<br>One Year Parts Warranty Included |                         |
| **Conveyor sold separately  |                         |

## Special Features:

- Full Color Touch Screen
- Weight/Photo Eye, Manual or Automatic modes of operation
- 96 Job Saves
- 100 weigh history with accuracy graphs
- Automatic zeroing function
- Painted tubular frame construction

## Optional Accessories:

- Infeed conveyor to feed scale
- Exit, incline conveyor

# US-6000 Conveyor Check-Weigh Scale

The US-6000 Check-Weigh Conveyor Scale offers exceptional accuracy and reliability for continuous-feed applications. Check-weigh bags, cartons, and finished goods to detect and discharge out of range product.

Touch screen controlled with pop-up windows, weigh history, job saves, accuracy charts and auto tare and auto zeroing functions.

### Special Features:

- Full Color Touch Screen
- Over/Under/Accept Display
- 96 Job Saves
- Accuracy chart and history
- 6" or 12" wide conveyor (varies based on carton size)
- 6' infeed conveyor (varies based on quantity of cartons in que)
- DC motors with adjustable speed controls
- Painted tubular steel framework
- 25 lb. digital dampened load cell (up to 100 lb. load cells available)
- Accuracy up to .002 lbs. (varies due to load cell)

### Options:

- Stack light
- Exit conveyor
- Discharge pusher/blower



| Specifications   |                           |
|--|---------------------------|
| Description:   | US-6000 Conveyor CW Scale |
| Weight:  | 175 lbs.                  |
| Dimensions (footprint):  | 26" x 36" x 48"           |
| Load height:   | Adjustable 30"-42"        |
| Load cell:   | (4) 10 kg. cells          |
| Accuracy:  | up to .007 lbs.           |
| Electric:  | 110/220V, 60/50hz         |
| Air:   | 40 psi                    |
| Scale controller, Conveyor, Manual, One Year Parts Warranty Included |                           |

# US-6000 Carton Check-Weigh System

Accurate shipping weight is the final checklist item before your package is sent to its destination. Our check-weigh system is accurate within 5 grams. It is designed for cartons 3"x 3" to 18" x 24" and weighing up to 50 lbs. that are typically fed from a box taper. The belt and roller conveyors can be customized.

The package is weighed on the US-6000, then fed onto a roller conveyor (see above). A pusher assembly pushes the carton that does not meet the desired weight to the gravity reject roller conveyor (see right).

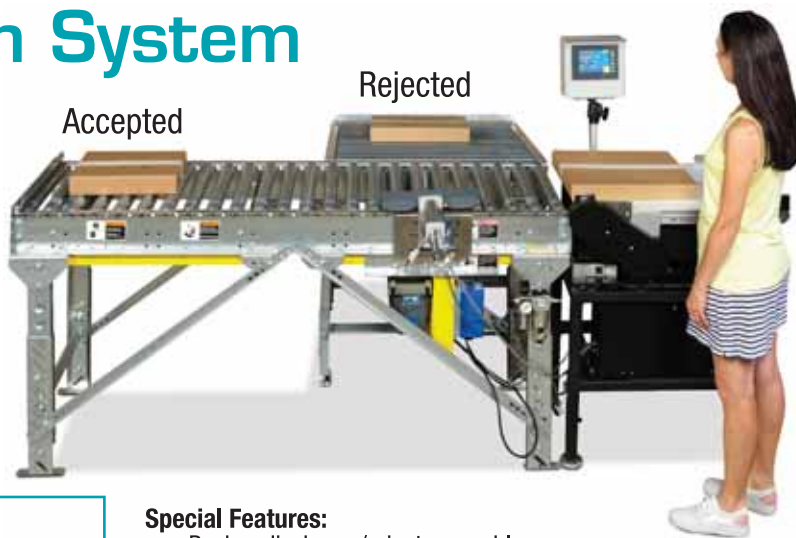

| Specifications                      |   |
|-------------------------------------|---|
| <b>Scale</b>                        | <b>Exit Conveyor</b>                                      |
| Weight: 175 lbs.                    | Power roller design                                       |
| Dimensions: 26" x 36" x 48"         | 20" wide  |
| Load Height: 30" – 42" (adjustable) | 6' long   |
| Load Cell: (4) 10 kg. cells         | 1.9" diameter x 16" long galvanized rollers on 3" centers |
| Accuracy: up to .007 lbs.           |   |
| Electric: 110/220V, 60/50Hz         | <b>Reject/Discharge Conveyor</b>                          |
| Air: 40 psi                         | Gravity fed roller design                                 |
| <b>Conveyor</b>                     | 30" wide  |
| Dimensions: 20" wide x 28" long     | 3' long   |
| Adjustable side guides              | .9" diameter x 16" long galvanized rollers on 3" centers  |
| Photo eye to detect box edge        |   |

### Special Features:

- Pusher discharge/reject assembly
- Driven roller exit conveyor (accept)
- Gravity reject conveyor (reject)
- Touch screen controlled:
  - Full color
  - Over/Under/Accept display
  - 96 job saves
  - Accuracy chart & history
- PLC operated

# Ultra Feed Series Conveyors

## UF-2000 Incline Conveyor

The UF-2000 Incline Conveyor transports loose or packaged product to table height, to check-weigh scales or to other downstream equipment.

### Special Features:

- Oversized product “catch” chute.
- Adjustable height and tilt.
- Adjustable discharge chute.
- Lightweight, extruded aluminum frame.
- 3/4” permanently lubricated bearings.
- Fixed speeds or variable speeds.



### Specifications/ Worksheet UF-2000

- A. Length \_\_\_\_\_  
B. Exposed belt width \_\_\_\_\_  
C. Cleat width \_\_\_\_\_  
D. Cleat height \_\_\_\_\_  
E. Cleat spacing \_\_\_\_\_

## UF-3020 Vibratory Hopper/Conveyor Light Duty

The UF-3020 hopper is built onto a cleated conveyor and it is typically used for lighter parts, such as molded plastic parts. This machine is often customized to fit your application, so there is flexibility:

- Hopper size
- Conveyor width
- Conveyor length
- Cleat spacing
- Cleat height

Parts should be clean without chemicals or coatings that could damage a belt or other conveyor surfaces.

### Specifications/ Worksheet UF-3020

- A. Length \_\_\_\_\_  
B. Exposed belt width \_\_\_\_\_  
C. Cleat width \_\_\_\_\_  
D. Cleat height \_\_\_\_\_  
E. Cleat spacing \_\_\_\_\_  
F. Discharge height \_\_\_\_\_  
G. Hopper size \_\_\_\_\_ (Cubic Ft.)  
H. Cubic foot \_\_\_\_\_



# UF-3040 Vibratory Hopper/Conveyor Medium Duty

The hopper is mounted to a stand with a vibratory pan feeder. This version is typically for light to heavy parts which feed easily on this type of feeder. Parts should not have sharp corners or edges that could damage a cleated belt. Parts should also be free of oils or other chemicals that could damage the belt.



## Specifications/ Worksheet UF-3040

- A. Length \_\_\_\_\_
- B. Exposed belt width \_\_\_\_\_
- C. Cleat width \_\_\_\_\_
- D. Cleat height \_\_\_\_\_
- E. Cleat spacing \_\_\_\_\_
- F. Discharge height \_\_\_\_\_
- G. Vibratory Feed Tray width \_\_\_\_\_
- H. Hopper size \_\_\_\_\_ (Cubic Ft.)
- I. Cubic foot \_\_\_\_\_

# UF-3060 Metal Bucket Hopper/Conveyor Heavy Duty

The UF-3060 Metal Bucket Hopper/Conveyor is engineered for heavy duty parts handling. The hopper is mounted on a heavy duty stand which also supports metal buckets.

This version is designed for heavy metal parts, such as fasteners. Products with sharp corners and edges or those with oil coatings are OK on this machine!

The UF-3060 operates at a 95° angle, saving space in your facility. The parts won't ride along guides to eliminate jamming.



## Specifications/ Worksheet UF-3060

- A. Load height \_\_\_\_\_
- B. Discharge height \_\_\_\_\_
- C. Discharge chute \_\_\_\_\_
- D. Hopper width \_\_\_\_\_
- E. Hopper volume \_\_\_\_\_
- F. Bucket size \_\_\_\_\_

## Roll-a-Print™ Print Stations

# Ti-1000Z Roll-a-Print “Fast” Printer

We should have called it our Ti-1000Z “Speedy Gonzalez” Roll-a-Print. Using Zebra print technology and Advanced Poly feeding and registration technology, the newest and fastest of our Roll-a-Print series can print up to 80 bags per minute. Bags feed continuously through the print head at 10” per second for outstanding print quality.

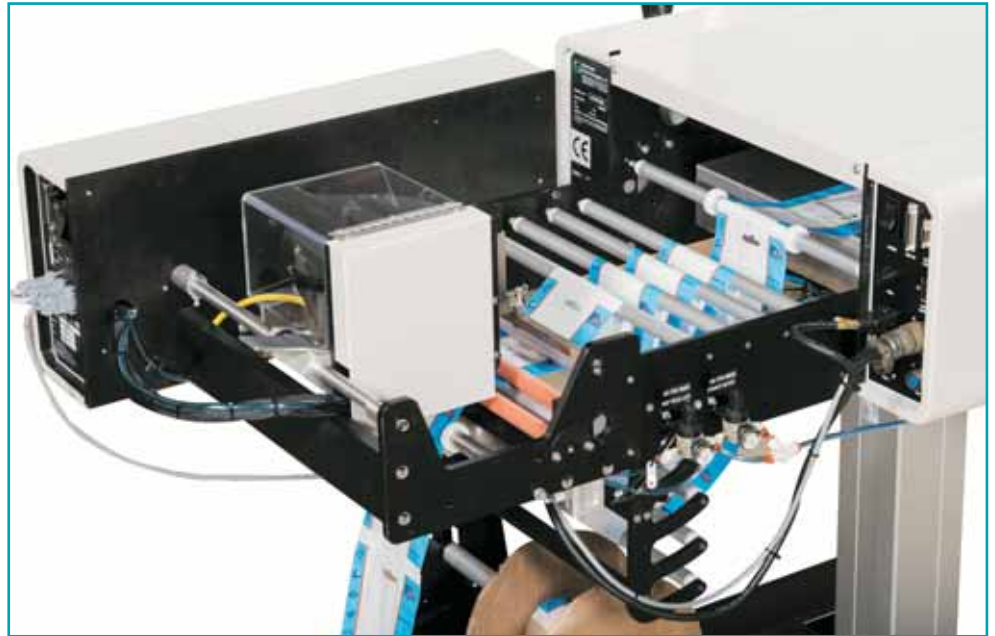

### Special Features:

- Perforation or photo optic registration system for precise thermal print registration
- Perfectly integrated with the T-1000, the Ti-1000Z RAP is operated from a single touch screen that also controls the bagger.
- 203, 300 or 600 dpi print resolution available
- 4”, 5” or 8” wide print heads available
- Film accumulator for continuous feeding and tension control
- Full color touch screen/PLC operation with alarm outputs



Shown here with our T-1000 Advanced Poly-Bagger™

# RAP-1400 & RAP-2800

## 6 Printers in 1!

- 1) Perforated or Pre-Opened Bags on Roll Printer – Print on non-printed or printed bags on rolls registering to the bag perforation or preprinted areas.
- 2) Roll Stock Printer – Print on film with the assurance of precise print registration with optical registration sensor. Or, set the repeat to print every 3", 10", or 20" for instance.
- 3) Add-On Printer – Have several baggers but no printers? Position the Roll-a-Print behind your bagger for inline printing. Or, need to add print to the other side of the bag? Then add this printer to your bagger/printer combination for additional printing requirements.
- 4) Stand-Alone Printer – With the winder attachment, print bags or roll stock film from a roll onto a roll, then rewind the rolls for later use on baggers or hand sealing equipment.
- 5) Inline Printer – Position the Roll-a-Print behind your existing bagger or form-fill-seal equipment. As your bagger feeds film, the print station supplies printed film on demand.
- 6) Two Color Printer – RAP-2800 has two print heads for two color printing. You select the ribbon colors.



RAP-1400



RAP-2800

### RAP-1400 Special Features:

- Print up to 5" wide on films up to 14" wide.
- Optical and perforation registration units.
- Microprocessor controls with menu driven operator panel, status LEDs and countdown counter.
- Prints directly to the surface of the film with no head adjustments for variable media thickness.
- Print on bags (Pre-Opened Advanced-Poly Bags on Rolls), roll stock, polyethylene, polypropylene, polyester and laminated films.

### RAP-2800 Special Features:

Three configurations available to meet your printing needs:

Option 1: (Shown above) Top & bottom printer – Print both sides of your POR or Pre-Opened Bags on Rolls, up to 5" wide print and 14" wide film.

Option 2: Two color printer – Print using two print heads, each with a different color ribbon, on one side of the film.

Option 3: Side-by-side printer – with two print heads side by side, print up to 10" total print area width on film up to 28" width.



Optional RS-10  
Roll-to-Roll Rewind Unit

# Bagger and Printer Comparison Charts

To assist in selecting the right bagger or printer for the job, the following information is provided:

| Description:         | T-200  | T-275   | T-300   | T-375  | T-1000   |
|----------------------|--|---|---|--|--|
| Bag Size             | 2" x 2" - 11" x 16"  | 2" x 2" - 11" x 16"   | 2" x 3" - 11" x 16"   | 2" x 3" - 11" x 16"  | 2" x 3" - 14" x 30" Std<br>4" x 6" - 18" x 36" Wide  |
| Standard Options     | Limited:<br>Bag deflator   | Bag deflator<br>Counting funnel<br>Compartment seal   | Bag deflator<br>Counting funnel<br>Compartment seal   | Bag deflator<br>Counting funnel<br>Compartment seal<br>Thermal Transfer<br>Printer   | Many standard<br>and custom<br>options   |
| Advantages           | Economical<br>Small footprint<br>Tabletop<br>Auto-seal           | Economical<br>Small footprint<br>Tabletop<br>Auto-feed<br>Auto-seal                           | Economical<br>Small footprint<br>Tabletop<br>Auto-feed<br>Auto-seal<br>Auto-tear off          | Small footprint<br>Tabletop<br>Auto-feed<br>Auto-seal<br>Auto-tear off<br>Printer- NBO   | Small footprint<br>Fully automatic<br>operation<br>Auxiliary infeed<br>High output   |
| Versatility          | Limited:<br>Lighter products<br>Manual loading<br>Manual bagging | Limited:<br>Lighter products<br>Manual loading<br>Semi-auto bagging                           | Lighter products<br>Auto loading<br>Auto bagging  | Lighter products<br>Auto loading<br>Auto bagging<br>Auto printing  | High versatility:<br>Auto loading<br>Auto bagging<br>Auto printing   |
| Applications         | Small kits<br>Literature<br>Sample products<br>Parts cage        | Small kits<br>Literature<br>Sample products<br>Parts cage<br>Electronic parts<br>Molded parts | Small kits<br>Literature<br>Sample products<br>Parts cage<br>Electronic parts<br>Molded parts | Small kits<br>Literature<br>Sample products<br>Parts cage<br>Electronic parts<br>Molded parts<br>Medical products<br>Prescriptions | Small-large kits<br>Literature<br>Sample products<br>Electronic parts<br>Molded parts<br>Medical products<br>Clothing<br>Anything but<br>powder and liquid |
| Product pass through | 3"   | 3"  | 3"-5"   | 3"-5"  | 4-3/4" -7-3/4"   |
| Production           | 5-15 bags/min.   | 10-30 bags/min.   | 25-30 bags/min.   | 20-25 bags/min.  | Up to 100 bags/min.  |
| Integration          | None   | Minimal<br>Parts counting,<br>or weighing   | Some Applications<br>Parts counting,<br>weighing, infeed<br>conveying                         | Some Applications<br>Parts counting,<br>weighing, infeed<br>conveying  | Full   |

Machines include, where applicable: Touch Screen, Funnel, Foot Switch, Guards, Manual, One Year Parts Warranty

| Description: | Ti-1000Z  | Roll-a-Print Series | T-375 Next Bag Out | T-1000 Next Bag Out |
|--------------|---|---------------------|--------------------|---------------------|
| Print Head   | 4"  | 4"                  | 4"/203 or 305 dpi  | 4"/203 or 305 dpi   |
| Print Speeds | 4", 6", 10"/sec. 203 dpi<br>3", 5", 8"/sec. 300 dpi | 3", 5", 8"/sec.     | 3" - 10"/sec.      | 3" - 10"/sec.       |
| Print Area   | 4" x 12"  | 4" x 12"            | 4" x 12"           | 4" x 12"            |
| Weight       | 40 lbs  | 200/265 lbs         | N/A                | N/A                 |
| Dimensions   | 23" x 13" x 16"                                     | 32" x 44" x 30"     | N/A                | N/A                 |
| Ribbon width | 2" up to 8"   | 2" up to 8"         | 2" up to 6"        | 2" up to 8"         |



# Special Purpose Systems

A modular system is formed when several pieces of Advanced Poly-Packaging's off-the-shelf equipment are joined together to form one system.

Because we have standardized equipment and options that are pre-engineered with prewired interface/communication ports, the pieces fit together like a puzzle.

If you're hand loading now, but later wish to automate counting and filling operations: 1) Add a parts counter, 2) Plug it in and 3) Turn on the Aux. button... it's that simple. Similarly, you can add a printer to print lot/date codes, barcodes, graphics, or add a scale to the system to check-weigh each kit to ensure quality of counts and components.

Our modular engineering concepts allow customers to improve their operations as their companies grow, while decreasing packaging costs.

Let our expert sales and support technicians help you select the right solution for your current operation, then let us grow your capabilities as your business expands, without the need to start over!

We design our systems "Modular," which means growth potential! See some of our Special Purpose Systems on the following pages.



Multi-bowl parts counter for bagging swing set hardware/fastener kits



Up to 12 stainless steel feeders count & release vitamins, medicines, candy, mints, etc.



Customized pneumatic pusher and funnel highlight the T-1000 "Money Bagger"

# TSP-1000 Seal-Pouch System



10 feet of loading section (shown);  
or 6' on shorter system

- Heavy duty chain transport system is designed for 24 hour/7 day use.
- Adjustable opening (positive opening to rectangular shape)
- Auto tensioning and alignment means no maintenance on the drive assembly
- Connect with the PLC via Ethernet, from your PC, to the TFT 10.4" SVGA color touch screen.
- Recipe management system, alarm tracking, user friendly settings.
- Hot air seal technology, continuous motion sealing, 1/8" seal



Adjustable work height (shelves, bin hoppers or partition tables optional)

Advanced Poly-Packaging's highest throughput bagger now gets some competition! Our T-1000 Advanced Poly-Bagger™, now in its third decade and still going strong, is now rivaled for versatility, speed and durability. At bagging rates more than 120 bags per minute, the Seal-Pouch System nudges ahead of the tested and proven T-1000 for speed!

Our Seal-Pouch System is a vertical-loading, horizontal-feeding system that incorporates the following components/features: 1) driven unwind stand, 2) bag registration device, 3) perforation separation assembly, 4) long or short loading section, 5) touch screen operator panel, 6) hot air sealer.

While this stainless steel pouch system was designed for food applications, it is also being used for medical, fastener/hardware, automotive and other industries.

#### Specifications

|                              |  |
|------------------------------|--|
| Feed rate:                   | Up to 8" per second                                    |
| Bag width:                   | 2.5" to 32"  |
| Bag length:                  | 3" to 20"  |
| Product pass-through:        | .5" to 8"  |
| System Dimensions:           | 32" x 264" (longer system)                             |
| Working height (adjustable): | 29" to 38"   |
| Loading section:             | 10' (or 6' for shorter system)                         |
| Seal:                        | Constant temperature, thermocouple controlled, hot air |
| Electric:                    | 208V/1/60hz  |
| Air:                         | 100 psi  |



Controlled tension with driven unwind stand to handle large diameter rolls for longer production runs.

#### Multi-mode operations:

- Continuous: Variable speed feed rates to pace your operators to achieve high bagging rates with guaranteed production.
- Index: High speed index rate for automatic or individual manual loading.
- Batch Index: Index any quantity of bags into the loading position, then load the batch all at once automatically or manually.

#### Patents Pending:

- Registration System - detects the bag opening; no registration marks required (non-printed or printed).
- Transport System - grabs and holds the top of the pouch (both front and back) for easy loading of light or heavy products.
- Sealing Mechanism - seals bags in a continuous motion, using hot air seal technology.

# ST-1000 Automatic Towel Inspection & Bagging System

**7,500 shop towels per hour.\* One operator.**

Actually, the operator is only needed if your application includes visual inspection of the product before it is bagged. It's easy to see how the Automatic Towel Inspection & Bagging System will save money!

Product is pulled from a dual hopper/conveyor and dropped to a conveyor, where it can be inspected, if necessary. When the product reaches the desired (programmed) weight, the conveyor advanced the product to a waiting, open bag on the T-1000 Advanced Poly-Bagger. The bag is sealed and conveyed to a shipping container or otherwise collected.

Why weigh the product instead of counting it? Weighing is faster and usually more accurate than counting and it's what our customers told us they want. You can actually have it either way with the ST-1000 since weight can be converted from count. Once the weight is established, you can simply let the machine operate and walk away. The system is driven by the T-1000 Advanced Poly-Bagger™ and its reputation for speed, reliability, versatility and simplicity!

\* based on continuous operation for 60 minutes; other products or non-continuous operation impact the amount of product bagged per hour (ex: 6,000 bar towels per hour).

## Special Features

- 5.7" Color Touch Screen Operator Panel/PLC
- Programmable optic sensor for scrap detection
- Quick-change parts design & off-the-shelf standardized parts
- Teflon-shield for extended Teflon life
- Independent Action Sealing
- Anti-jam method
- Preset and Totalling counters
- Numerous options available, including wide model bagger, extended takeaway conveyor, bin extender and spare parts kit.



## Specifications

|                |   |
|----------------|---|
| Description:   | ST-1000 Automatic Towel System              |
| Configuration: | Extended Drop Frame                         |
| Bag Size:      | Up to 15"x 36" (requires wide model bagger) |
| Electric:      | 110V/60hz (20a dedicated circuit)           |
| Air:           | 60psi/2.5cfm                                |

# BF-4000 Box Filling System

## *For Automatic Bag Counting into Cartons*

This side-by-side automatic box filling system takes pre-made boxes and feeds them from a belt-driven conveyor onto a loading station, where they are filled, then released on a return roller conveyor.

The BF-4000 easily ties in with other infeed equipment such as horizontal and vertical conveyors, bagging machinery and rotary scales.

Product (bags or loose parts) is counted as it feeds into the cartons. When a carton is full, an accumulator closes above the carton allowing continuous feeding, while the next empty carton is fed into the loading position.

Other configurations are available, including in-line configurations, top & bottom configurations and counting or net-weighting systems.



Side-by-side configuration shown here.

### Special Features:

- Pneumatic transfer arm
- Photo eye with leading edge/delayed programming to count bags
- Touch Screen controlled through T-1000 bagger (central operator panel)
- Accumulator for continuous feeding operations

### Specifications

|   |  |
|---|--|
| Description:  | BF-4000 Box Filling System             |
| Configuration:  | Side-by-side, over-the-top, or in-line |
| Carton Size:  | Up to 12" wide, any length             |
| Weight:   | Varies depending on length             |
| Dimensions (footprint):   | Varies depending on configuration      |
| Electric:   | 110/220V, 60/50hz                      |
| Air:  | 80 psi                                 |
| Driven Conveyor, Roller Conveyor, Accumulating Funnel, Manual, One Year Parts Warranty Included |  |

# Refurbished Equipment

## Increased Savings Are In the Bag!

Fully Refurbished, Warrantied and Guaranteed Equipment.

Since 1987, Advanced Poly-Packaging, Inc. has been providing quality refurbished equipment, specializing in APPI and APS models:



### T-1000 Advanced Poly-Bagger™

The T-1000 is APPI's most popular bagger. It has the speed, versatility, durability and reliability to be put to the test in countless applications. You can expect a "good as new" machine that seamlessly integrates with our line of scales, parts counters, conveyors and printers (detailed T-1000 description on pg. 12).



### HS-100® Excel

Refurbished general purpose APS bagger to dispense, open, seal and tear bag sizes ranging from 2.5" x 3" to 10.5" x 22" and thickness from 1.5 to 4 mil.

### AB-180®

Newer refurbished bagger for a wide variety of applications. Bag sizes ranging from 2" x 5.5" to 11" x 25" and thickness from 1.5 to 4 mil.



### H-100® Bagger

Completely refurbished, all-purpose bagger for packaging a wide range of parts, sizes, configurations and counts into Pre-Opened Advanced Poly-Bags on Rolls. Plus, many upgraded capabilities and components are added, including our AP723 Anti-Jam feature, modified (safer) gripper mechanism and upgraded electronics.

## Warranty

Not only does Advanced Poly-Packaging, Inc. refurbished equipment have the same period warranty as new equipment, but we also guarantee the equipment to be in "like new" condition. This means your equipment looks like new, functions like new, and lasts like new. In fact, we guarantee it!

To our expert machine strippers, builders, and electronic technicians, refurbishing a machine includes fully disassembling the machine to its frame, removing all paint by stripping, scraping and sandblasting, repainting, black oxidizing and refinishing. We replace even slightly worn parts, as well as replace all air lines. We rebuild or replace valves and cylinders, assemble, adjust, lubricate, and test electric / electronic systems, mechanical systems and pneumatic systems. We do not ship your system until it meets our strictest final inspection and test-cycles for at least 48 hours.

## Parts And Service

Unlike typical machinery dealers, Advanced Poly-Packaging, Inc. provides complete customer support with service, parts, and repairs both before and after the sale. You can order all replacement parts using the original part number. In addition, we offer and maintain extended service contracts with emergency repair service, loaner modules, and repairs to original specifications.

## Considerable Savings

Because we purchase parts directly from the manufacturer, we are able to pass our savings on to you. And in most cases, electronic boards can be repaired, instead of spending hundreds of dollars from not having to purchase new electronic motherboards or auxiliary boards. We have standard "bench" rates for board repairs and guaranteeing labor will not exceed quoted costs.



### UC-2400

Fully refurbished, belt-driven vibratory parts counter with thick coated stainless steel bowl.



### Supply Hoppers

Bulk vibratory supply hopper automatically feeds vibratory bowls to maintain a consistent level of parts in the bowl. Height is adjustable and swivels to allow for fast clean out of parts.

Accu-Scale, H-100, DAC, are trademarks of Automated Packaging Systems, Inc.

# Product Evaluation Services

Advanced Poly-Packaging, Inc. offers a free Product Evaluation of your products. Once receiving a sample of your product, our problem solvers will determine the feasibility of packaging your product with detailed analysis, including: proposed equipment, required and suggested options, packaging speeds, potential problems and suggested bag sizes. Upon request, we will create a custom DVD of your product running through our equipment and return your packaged product for you to evaluate. Please complete the following information form to get us started!

|                           |  |                             |                |                                    |
|---------------------------|--|-----------------------------|----------------|------------------------------------|
| <b>CONTACT INFO.</b>      | Company Name                                   |                             | Contact(s)     |                                    |
|                           | Address  |                             | City/State/Zip |                                    |
|                           | Telephone                                      |                             | Email          |                                    |
|                           | Fax  |                             | Website        |                                    |
| <b>PRODUCT</b>            | Product Description                            |                             |                | Weight / Count                     |
|                           | Existing Equipment                             |                             |                |                                    |
| <b>CURRENT OPERATION</b>  | Current Method of Packaging                    |                             |                | No. Hours / Day                    |
|                           |  |                             |                | No. Bags / Day                     |
|                           |  |                             |                | No. Personnel                      |
| Current Labeling          |  |                             |                |                                    |
| <b>PROPOSED OPERATION</b> | Bag Sizes (List All Sizes & Annual Quantities) |                             |                |                                    |
|                           | Desired Production Speed                       |                             |                |                                    |
|                           | Goals (Please number in order of importance)   |                             |                |                                    |
| ___ Labor Reduction       |  | ___ Simplify Operation      |                | ___ Increase Automation            |
| ___ Increase Production   |  | ___ Material Cost Reduction |                | ___ Increase Printing Capabilities |
| Submitted by              |  |                             | Date           |                                    |

**OTHER REQUIREMENTS OR CONSIDERATIONS (Check the equipment you are interested in):**

- Baggers, Tabletop
- Baggers, Vertical
- Baggers, Horizontal
- Baggers, Medical
- Baggers, Refurbished
- Bags, Pre-opened on Rolls (or in boxes)
- Bags, Recloseable
- Bags, Tyvek®
- Bags, Foil
- Bags, Wicketted/Gussetted
- Bags, Header (retail)
- Bags, Flat
- Computers, Work Stations
- Conveyors, Box Lines
- Conveyors, Infeed
- Conveyors, Bucket
- Conveyors, Take-away
- Conveyors, Refurbished
- Counters, Parts Counter
- Counters, Refurbished
- Custom Feeders, Custom Production
- Integration
- Custom, Engineering
- Diverters, Counting
- Engineering, Consulting
- Film, Printed Roll Stock
- Film, Non-printed R.S.
- Fillers, Volumetric/Auger
- Hoppers, Vibratory Supply
- Printers, Hot Stamp
- Printers, Inline
- Thermal Transfer Printers, Label
- Thermal Transfer Printers, Two Sided
- Printers, Two Colors
- Ribbon, Hot Stamp
- Ribbon, Thermal Transfer
- Scales, Net-Weigh
- Scales, Weigh-Counting
- Scales, Check-Weigh
- Scales, Refurbished
- Service, Contracts / PM
- Software, Label Creation
- Verifiers, Barcode
- Other



## Advanced Poly-Packaging, Inc.

**1-800-754-4403**

**U.S.A.**

1331 Emmitt Rd. • Akron, OH. 44306

330-785-4000 • Fax 330-785-4010

[www.advancedpoly.com](http://www.advancedpoly.com) • [sales@advancedpoly.com](mailto:sales@advancedpoly.com)

**U.K.**

APP (UK) Ltd.

Unit 2 Vernon Place, Staverton, Gloucester GL2 9QL

+44 (0) 1452 854445 • Fax +44 (0) 1452 854485

[www.advancedpoly.com](http://www.advancedpoly.com) • [salesuk@advancedpoly.com](mailto:salesuk@advancedpoly.com)



Member



Cert. No. CA1545